



Make it your

Home



2	Living room
12	Dining
16	Entertainment
24	Bedroom
30	Kids
34	Shelving
42	Storage
50	Home office

The USM world

60	Strong core values
62	Product information
72	Colors & surfaces

Home is our personal retreat, the private space where we share special time with family and friends.

It is a reflection of our lifestyle, our attitudes and the things that mean the most to us. As our lives and tastes change, our home evolves with us – always in synch with our current needs.

USM Modular Furniture is designed to accompany us through different phases of life. It adjusts to new demands, ready to take up different functions in our home – a constant in our ever-shifting lives. On the following pages we present the diverse world of USM: from minimal to eclectic, from functional to decorative. Always modular and adjustable. Furniture for a lifetime made with great care in Switzerland.



Online Configurator
Design your individual piece of USM online!



Customized Service
Visit a USM Showroom or one of our 400 international sales partners worldwide for individual support. Find your closest USM professional online.

www.usm.com

Living room

It is simply about living your ideas, your style.

Make your home personal. Clear lines, versatile modularity: USM Haller lets you decide. Unobtrusive but essential, it adapts to your lifestyle, your changing needs, your personal taste. An enduring companion.



- 1 Sideboard
W/D/H: 3023/373/740 mm
with four drop-down doors



Living room



↙
2 Sideboard
 W/D/H: 2273/373/740 mm
 with two drop-down doors
 and three extension doors

→
**3 USM Haller E
 TV/HiFi unit***
 W/D/H: 1523/373/390 mm
 with one drop-down door
 and one cable cut-out
 *with a dimmable cold or
 warm white light



4 Sideboard
 W/D/H: 1523/373/740 mm
 with four drop-down doors



5 Sideboard
 W/D/H: 2273/373/740 mm
 with two drop-down doors
 and one extension door
 with box insert



6 Sideboard
 W/D/H: 3773/373/740 mm
 with three drop-down doors
 and three extension doors

Living room



7 USM Haller E
Glass showcase*
W/D/H: 773/523/1090 mm
with three glass doors
* with a dimmable cold or
warm white light

8 Glass showcase
W/D/H: 3023/373/740 mm
with eight glass doors

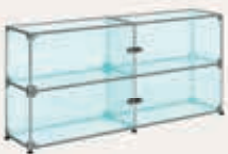

9 Glass showcase
W/D/H: 1523/373/740 mm
with four glass doors



10 USM Haller occasional
table, square
L/D/H: 750/750/370 mm
Brown oiled oak veneer



11 Sideboard
W/D/H: 1023/1023/540 mm



12 Side table
W/D/H: 523/373/390 mm
with one fixed shelf



Living room



Create the colour combination of your dreams with our configurator.

↙
13 Storage unit
W/D/H: 2273/373/915 mm
with six drop-down doors
and three extension doors

↘
14 Storage unit
W/D/H: 2273/373/2490 mm
with fifteen drop-down doors
and six flip-up doors





Living room

↓ 15 Sideboard
W/D/H: 723/723/390 mm

↘ 16 USM Haller E
Glass showcase*
W/D/H: 1523/373/1790 mm
with three drop-down doors
* with a dimmable cold or
warm white light

↘ 17 USM Haller occasional
table, square
L/D/H: 750/750/370 mm
Transparent glass





Dining

Sharing happiness with family and friends is priceless.

It is often little things that make life richer. Spending time with loved ones, eating, talking, laughing together. All it takes is a table to gather around. Pure and simple in design, the USM Haller Table allows you to dine in style.



↙
 18 USM Haller table
 Rectangular (combination)
 L/D/H: 1500/1500/740 mm
 Pure white powder-coated MDF

↙
 19 Sideboard
 W/D/H: 1523/373/565 mm
 with two drop-down doors

→
 20 Serving trolley
 W/D/H: 773/523/580 mm
 with a handle and casters



21 Sideboard
 W/D/H: 1523/373/740 mm
 with two drop-down doors



22 Sideboard
 W/D/H: 2273/373/640 mm
 with three drop-down doors



23 USM Haller table
 Rectangular
 L/D/H: 1750/750/740 mm
 Pastel gray laminate



24 Serving trolley
 W/D/H: 773/523/585 mm
 with a handle and casters

Dining

↙
25 Shelving
 W/D/H: 2273/373/1090 mm
 with six drop-down doors

↘
26 USM Haller table
Rectangular
 L/D/H: 1750/1000/740 mm
 Steel blue, back lacquered
 clear glass



27 Shelving
 W/D/H: 1523/373/1090 mm
 with four drop-down doors



28 Shelving
 W/D/H: 2273/373/1315 mm
 with seven drop-down doors
 and two extension doors
 with box insert



29 USM Haller table Square
 L/D/H: 750/750/740 mm
 Back-lacquered clear glass
 Gentian blue

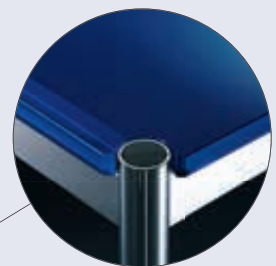

Classy Glass
 Back-lacquered
 glass tables are as
 iconic as they are
 durable and easy
 to clean.



Trends come and go while classic design is constant.

Clean in shape, honest in materialisation, timeless in design – USM Haller exists beyond trends. The beat of your life might change from time to time, another must-have home gadget might arrive. USM stays and adapts.



30 Sideboard

W/D/H: 3773/523/665 mm
with five drop-down doors
and five extension doors
with box insert



Entertainment



↙
31 Sideboard
W/D/H: 2273/373/740 mm
with three extension doors

↙
32 Low TV/HiFi unit
W/D/H: 1523/273/290 mm
with one drop-down door



33 Sideboard
W/D/H: 1523/373/565 mm
with four drop-down doors



34 Sideboard
W/D/H: 1523/373/740 mm
with two drop-down doors



35 Low mobile TV/HiFi unit
W/D/H: 1523/373/430 mm
with two divider shelves,
cable cut-out and casters



36 Low mobile TV/HiFi unit
W/D/H: 1523/373/430 mm
with two drawers,
counterweight and casters



37 Sideboard

W/D/H: 2023/523/740 mm
with one drop-down door,
one extension shelf,
three extension doors
and cable cut-out



Entertainment

↙
38 Storage unit
W/D/H: 1523/373/740 mm
with two drop-down doors

↘
39 Low mobile TV/HiFi unit
W/D/H: 3023/523/430 mm
with four drop-down doors
and casters



40 Sideboard
W/D/H: 1523/373/565 mm
with two drop-down doors



41 Low mobile TV/HiFi unit
W/D/H: 1523/373/430 mm
with two drop-down doors
and casters



42 Low TV/HiFi unit
W/D/H: 2273/523/390 mm
with two drop-down doors,
one flip-up door
and one fixed shelf



43 Side table
W/D/H: 773/373/565 mm
with one drop-down door



Bedroom

Enjoy the peace and relax.

A bedroom is a place to relax, to recharge – your sanctuary. With its sheer simplicity, USM design helps you to ease your mind – offering enough variations to create your own personal sense of calm.



44 Storage unit
W/D/H: 1873/373/390 mm
with three drop-down doors



Would you like this piece of furniture to be wider, higher or lower? Configure your own furniture online.



Bedroom

- ↙
45 Side table
 W/D/H: 523/373/610 mm
 with one drop-down door
- ↘
46 Storage unit
 W/D/H: 2273/373/890 mm
 with nine extension doors



Spacious drawers
 Discover the full
 range of smart
 inner organizational
 elements — p. 63.



47 Storage unit
 W/D/H: 2273/523/565 mm
 with three extension doors
 and six A6 drawers



48 Storage unit
 W/D/H: 1523/523/915 mm
 with four A6 drawers
 and six extension doors



49 Storage unit
 W/D/H: 773/373/915 mm
 with two drop-down doors,
 two divider shelves and
 one extension door



Bedroom



↙
 50 USM Haller E
 Side table*
 W/D/H: 523/373/610 mm
 with one drop-down door
 *with a dimmable cold or
 warm white light

→
 51 Side table
 W/D/H: 418/523/540 mm
 with one A6 drawer



USB chargers ensure that all mobile devices are powered 24 hours a day and transform the design classic into a charging station.



52 Side table
 W/D/H: 773/373/840 mm
 with two drop-down doors



53 Storage unit
 W/D/H: 1023/373/565 mm
 with two drop-down doors



54 Side table
 W/D/H: 773/373/740 mm
 with one drop-down door



55 Side table
 W/D/H: 523/373/565 mm
 with one drop-down door

Kids

A playful start to grow into a great future.

Why not add a bit of color to your design? USM Haller marks a playful spot in your children's room. It serves as a toy box, a bookshelf or storage. A lifelong companion, growing with your children as their needs change.



↙
56 Shelving
W/D/H: 3273/373/2140 mm
with ten drop-down doors

→
57 Toy box
W/D/H: 373/373/390 mm

↘
58 Toy box
W/D/H: 523/523/430 mm
with casters



59 Desk with toy box
W/D/H: 1273/523/580 mm
with casters



60 Storage unit
W/D/H: 1523/373/1090 mm
with four drop-down doors



61 Low storage unit
W/D/H: 2023/373/390 mm
with four drop-down doors

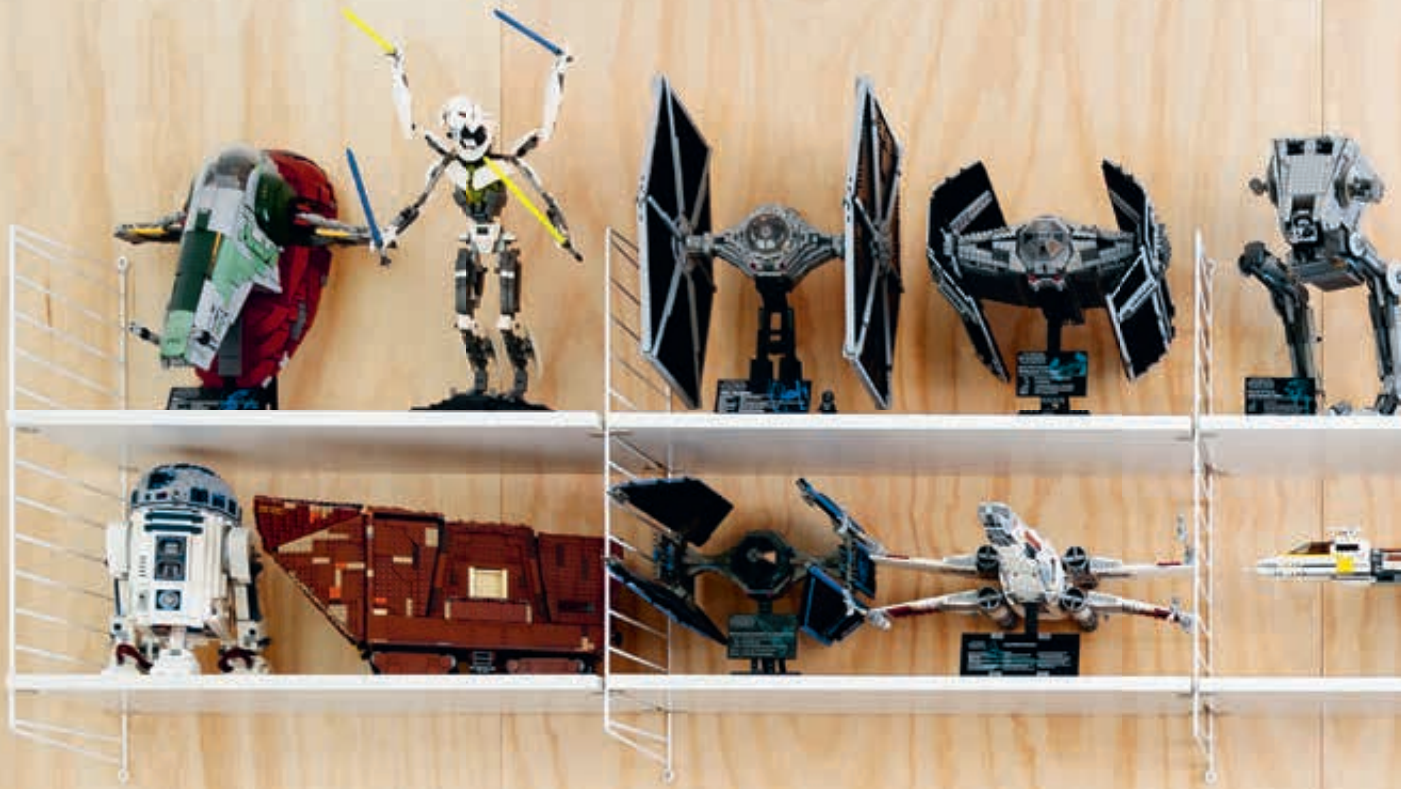

LEARN



62 Low mobile storage unit
W/D/H: 3023/523/490 mm
with four drop-down doors
and casters



Shelving

Beauty and function from both sides.

Whether it's your library or a collection of anything you hold dear, make it accessible from both sides. USM Haller remains discreet, focusing all the attention on what you place on it – minimalist design at its very best.



63 USM Haller E
Room divider*
W/D/H: 2523/373/1475 mm
with seven drop-down doors
and one glass door
*with a dimmable cold or
warm white light



Shelving

↙
64 Room divider
W/D/H: 1523/273/2990 mm
with three drop-down doors

↙
65 USM Haller occasional
table, square
L/D/H: 750/750/370 mm
Back-lacquered
clear glass, USM brown

→
66 Shelving
W/D/H: 2273/373/1940 mm
with six drop-down doors





Shelving





67 Shelving

W/D/H: 2273/373/1440 mm
with three drop-down doors
and three divider shelves



With our configurator you
can playfully create your own
individual furniture.



68 Shelving

W/D/H: 2273/373/2140 mm
with two flip-up doors,
four drop-down doors
and three extension doors



69 Shelving

W/D/H: 3023/373/2140 mm
with one drop-down door



70 Shelving

W/D/H: 3523/373/1790 mm
with ten drop-down doors



71 Shelving

W/D/H: 3773/373/2140 mm

Shelving



↙
72 USM Haller E
Glass showcase*
W/D/H: 3773/373/915 mm
with ten glass doors
*with a dimmable cold or
warm white light

↓
73 USM Haller E
Shelving*
W/D/H: 1873/473/3280 mm**
* with a dimmable cold or
warm white light
**This furniture has special dimensions,
our sales partners will be happy to
advise you

↓
74 Side table
W/D/H: 523/418/475 mm
with casters



Storage

Our versatility with an unassuming face.

Thanks to its modularity and timelessness, USM fits into every environment, fulfilling a wide range of functions within your home. It adapts to your needs and taste. And it helps you organise your home, offering all the space you need – wherever you want it.



↙
75 Mobile pedestal
 W/D/H: 773/523/755 mm
 with two drop-down doors
 and one extension door
 with box insert and casters

→
76 Shelving
 W/D/H: 523/373/1590 mm
 with three extension doors
 and box insert



Organizing trays
 Discover the full
 range of smart
 accessories —
 p. 63.



77 Sideboard
 W/D/H: 1523/373/890 mm
 with two extension doors
 and counterweight



78 Shelving
 W/D/H: 773/373/1090 mm
 with three drop-down doors



79 Mobile pedestal
 W/D/H: 523/373/605 mm
 with three extension doors
 with box insert and casters

Storage



80 Glass showcase
W/D/H: 1023/373/1740 mm
with four drop-down doors
and six glass doors



81 Sideboard
W/D/H: 2273/723/890 mm
with six drop-down doors
without cover*

* Cover is not available
in the USM standard range.



**82 USM Haller E
Glass showcase***
W/D/H: 1523/373/1440 mm
with eight glass doors

* with a dimmable cold or
warm white light



83 Sideboard
W/D/H: 1523/723/915 mm
with six drop-down doors
and six extension doors



84 Glass showcase
W/D/H: 1023/373/1340 mm
with two drop-down doors
and two glass doors



85 Glass showcase
W/D/H: 773/373/1440 mm
with four glass doors





↙
86 Wardrobe
 W/D/H: 2273/723/1790 mm
 with two drop-down doors,
 two extension doors and
 box insert, two flip-up doors,
 and a clothes rail

→
87 Wardrobe
 W/D/H: 1273/523/1790 mm
 with one flip-up door, three
 extension doors and box insert,
 one drop-down door, one
 extension door, one fixed shelf,
 a clothes rail and a pull handle



88 Wardrobe
 W/D/H: 1523/523/1265 mm
 with seven extension doors
 with box insert and
 a clothes rail



89 Wardrobe
 W/D/H: 773/373/1915 mm
 with two extension doors with
 box insert and a clothes rail



90 Wardrobe
 W/D/H: 2723/1473/1790 mm
 with one drop-down door,
 four extension shelves and
 one extension door with box
 insert and two divider shelves
 and three clothes rails



Storage



Design your individual piece of USM online!

↙
91 **Wardrobe**
W/D/H: 1523/373/1440 mm
with three drop-down doors

↘
92 **Shelving**
W/D/H: 1023/373/815 mm
with two drop-down doors



Home office

Feel at home while you work at home.

The home office is a natural part of modern working life. An inspiring environment is not only stylish but enhances well-being and productivity. USM adds quality to the workplace in your home – and to your life at large.



93 Shelving

W/D/H: 3023/523/740 mm
with five drop-down doors,
two A6 drawers and one
extension shelf



Home office

↓
94 **USM Haller E Shelving***
W/D/H: 773/373/1090 mm
with two drop-down doors,
one extension shelf and
one fixed shelf
*with a cold or warm white light
on opening the compartment
plus a USB charger

↓
95 **USM Haller desk
Rectangular**
L/D/H: 1500/750/740 mm
Pure white powder-coated MDF

↓
96 **Mobile pedestal**
W/D/H: 418/523/605 mm
with three A6 drawers,
with counterweight
and casters



↓
97 Shelving
W/D/H: 3523/373/1790 mm
with nine drop-down doors and
four extension doors

↓
98 USM Haller desk
Rectangular
L/D/H: 1500/750/740 mm
Back-lacquered clear glass,
pure white



Home office



↙
99 Mobile pedestal
 W/D/H: 418/523/605 mm
 with one A6 drawer and
 one A4 drawer, with
 counterweight and casters

→
100 Shelving
 W/D/H: 773/373/1090 mm
 with two drop-down doors,
 one extension door with box insert
 and cable cut-out on the backwall



101 Shelving
 W/D/H: 773/373/1790mm
 with two drop-down doors



102 Sideboard
 W/D/H: 1523/373/740mm
 with two drop-down doors
 and two extension doors
 with filing frames



103 Shelving
 W/D/H: 773/373/1440mm
 with two drop-down doors



104 Shelving
 W/D/H: 1273/523/740mm
 with two drop-down doors

Home office





105 Shelving

W/D/H: 3123/2623/2640 mm
with six drop-down doors
and six extension doors
with filing frames



106 USM Haller E Shelving*

W/D/H: 2023/548/1090 mm
with two drop-down doors,
two extension doors
and one extension shelf

* with a dimmable light and a cold or warm white light on opening the compartment plus a USB charger



The golden yellow work and charging station boosts the energy in your home office. The barely visible lights and USB chargers embedded in the tubes can be disconnected and moved at any time.



Light when compartment is opened – sensor-controlled lights in drawers and compartments turn on automatically when opened.



107 Shelving

W/D/H: 1523/373/1090mm
with four extension doors
and filing frames



108 Mobile pedestal

W/D/H: 1023/373/605mm
with four drop-down doors
and casters



109 Shelving

W/D/H: 3523/373/1790 mm
with thirteen drop-down doors

110 USM Haller desk Rectangular

L/D/H: 1500/750/740mm
Pearl gray laminate

Home office



111 USM Kitos M Plus desk
L/D/H: 1750/750/700–1200 mm
Pearl gray laminate

112 Mobile pedestal
W/D/H: 418/523/605 mm
with three A6 drawers,
with counterweight and casters



Strong core

values

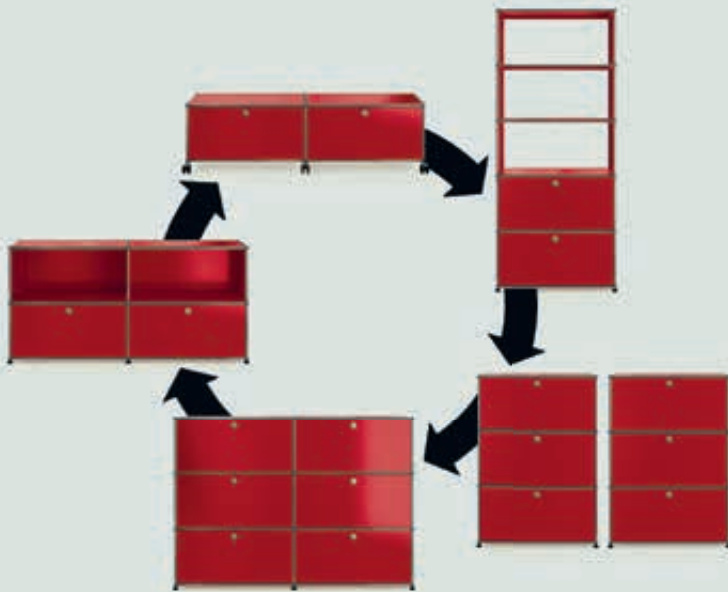

Form follows you

Unlike many static design classics, celebrating individuality by adapting design and function to its user. For more than 50 years, flexibility, durability and consequently sustainability are core values of the USM brand. USM Modular Furniture is designed to be reconfigured – at any time.

Sustainable concepts and actions

Developing solutions that respond to changing needs while remaining environmentally conscious has always been a USM philosophy. Since the beginning, and throughout USM's development, handling energy, emissions, materials and production methods in a responsible manner has been a key mission. In this regard, the longevity of USM products is of utmost importance. The longer the product can be used, the less impact it has on the environment. High-quality, durable materials, manufactured with the latest environmentally friendly technologies, guarantees a long, useful life for our product.



Made in Switzerland

Founded in 1885, USM is a family business now in its fourth generation. «Made in Switzerland» to us is both a promise and an obligation. It stands for precision, quality, dependability, first-rate materials, careful workmanship and total commitment – on behalf of customer interest and out of respect for the environment.



Founded in 1885 and headquartered in Münsingen, Switzerland, USM today is still a family-owned and family-led business, now in its fourth generation.



Worldwide services

USM provides trained specialists in furniture configuration, delivery and installation to ensure professional customer support. For USM assembly and repair, contact us directly or one of our 400 authorised sales partners in 40 countries, guaranteeing top-quality service around the world. Our modular system embodies dependability, and our customer service guarantees that you will receive quick, personalised answers to your questions. For customized advice, do not hesitate to visit our showrooms. USM has established a prominent reputation and international presence with flagship stores in Bern, Berlin, Düsseldorf, Hamburg, London, Munich, New York, Paris, Stuttgart and Tokyo that showcase local culture and offer technical support.

USM Haller

The USM Haller system provides a wide variety of elements in standard sizes. Widths, depths and heights are indicated below. All measurements refer to the distance between axes.



Your safety matters to us. Check out the USM safety instructions now. www.usm.com/safety

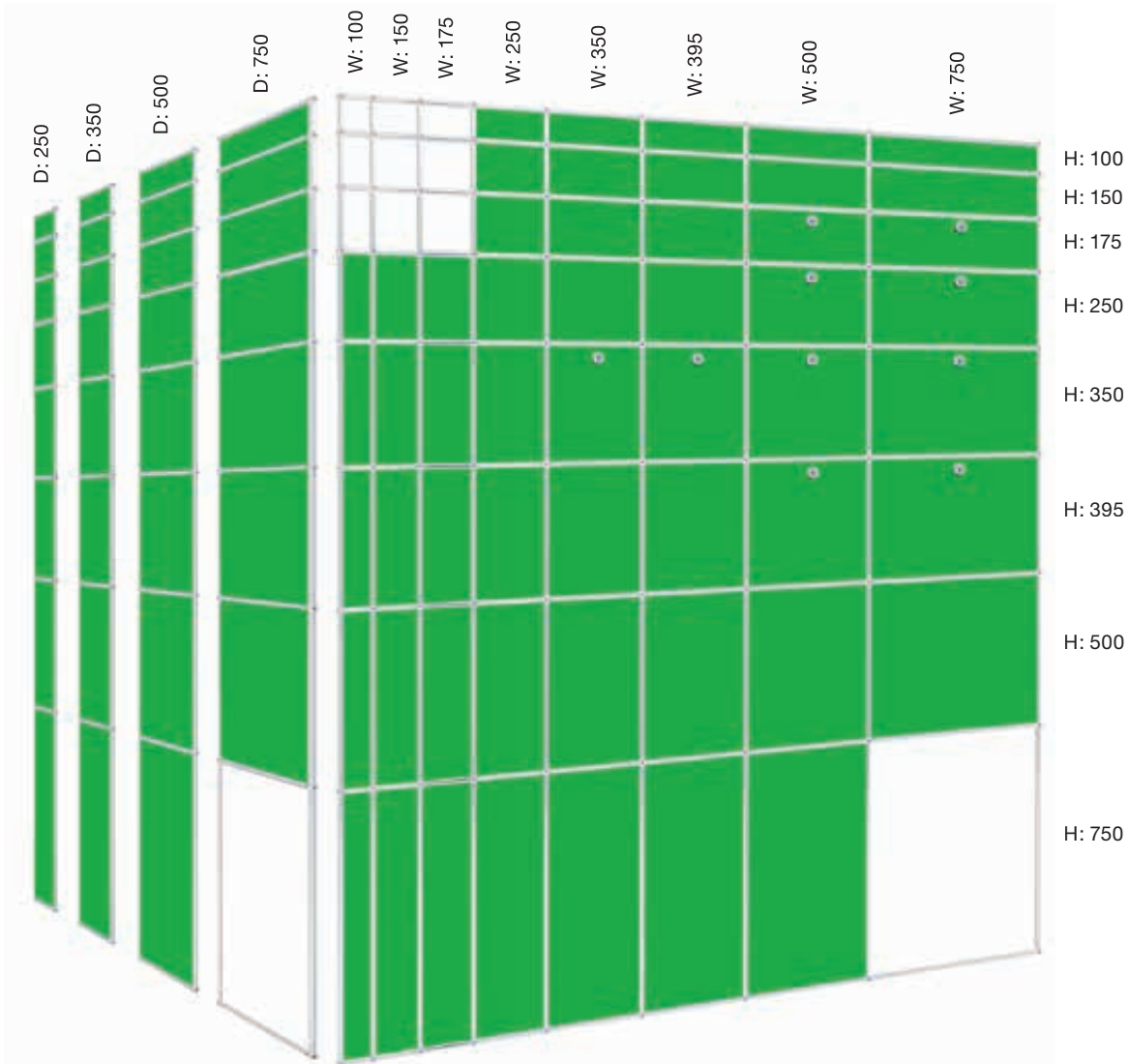
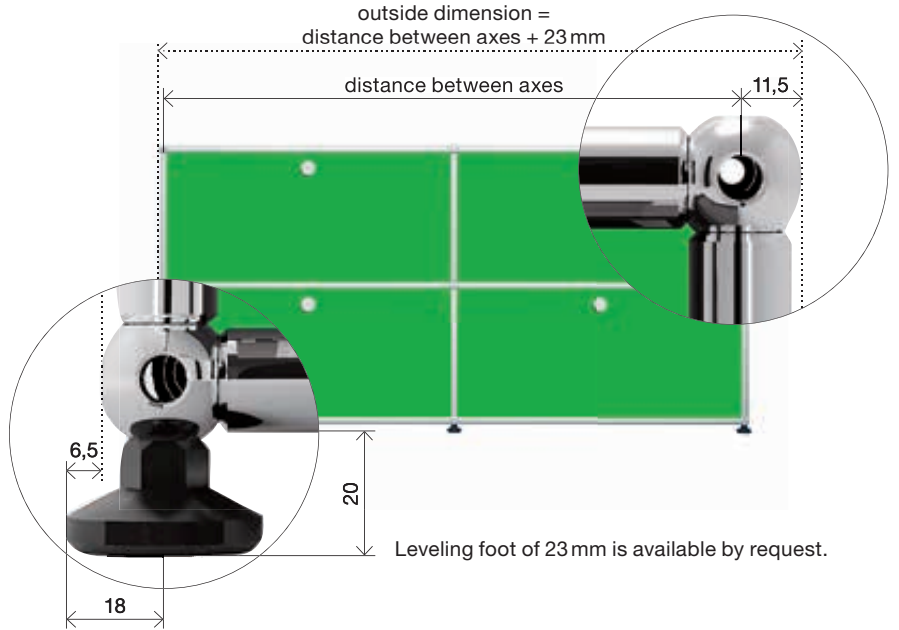

Panels

Doors

Shelves and drawers

Accessories

- 1 Metal panel
- 2 Glass panel
- 3 Acoustic panel
- 4 Perforated metal panel*

- 5 Metal flip-up door*
- 6 Glass door
- 7 Acoustic drop-down door*
- 8 Metal drop-down door
- 9 Metal extension door*

- 10 Metal divider shelf
- 11 Glass divider shelf
- 12 Metal extension shelf
- 13 Metal angled shelf
- 14 Extension filing set with extension shelf
- 15 Small drawer D: 500
- 16 A6 drawer D: 500
- 17 A5 drawer D: 500
- 18 A4 drawer D: 500
- 19 Extension filing set D: 500

- 20 Hanging file baskets
- 21 Metal box insert
- 21a Slide profile for metal box insert
- 22 Cable cut-out
- 23 Metal, magnetic bookend
- 24 USM Inos Box
- 25 USM Inos DVD tray
- 26 USM Inos CD tray

- 27 USM Inos angled file trays
- 28 USM Inos card box set
- 29 Bookend for bookshelf panel (D: 350)
- 30 USM Inos C4 box set, open
- 31 USM Inos C4 box set, closed
- 32 USM Inos drawer organizer set

Start configuring your individual piece of USM now!
www.usm.com



*Acoustic version available.
 USM Inos accessories are available in graphite black and light gray.

Illustration: USM Haller in D: 500 mm.
 All measurements in mm.

USM Haller E

Application Options

A modular structure of your design, either completely or partially equipped with e-Balls and e-Tubes, is connected to a source of electricity. The structure itself conducts the low voltage electricity to the desired location using the e-Balls, e-Connectors and e-Tubes to form a circuit. USB chargers or light sources can be snapped into place in pre-cut recesses. The power supply is drawn from any point near the ground. The power supply cable is attached to a Haller e-Ball, and the power adapter is subsequently tucked underneath the furniture until only the operating switch remains visible. From this point the power supply requires no further cables but rather is integrated into the structure of the furniture.

- 1 **Glass Panel**
Glass elements can be illuminated throughout.
- 2 **Without Metal Paneling**
Compartments without metal paneling can be completely illuminated.
- 3 **With Metal Paneling**
Compartments with metal paneling can be illuminated from the front.
- 4 **Compartment with an Extension Shelf**
The entire compartment with an extension shelf can be illuminated.
- 5 **Drop-Down and Extension Door**
Via the "Light When Compartment Is Open" function, the light automatically turns on when the door is opened.
- 6 **Angled Shelf**
The presentation space is illuminated from the front.
- 7 **Floor Lighting**
With floor lighting, the light shines at a 25-degree angle under the furniture.
- 8 **Ambient Lighting**
The light is directed vertically towards the back, illuminating the surroundings with a warm glow.
- 9 **e-USB Charger**
It can be integrated in the same places as the e-Lights.



Winner of the German Design Award 2019 for outstanding design quality in the Office Furniture category



Winner of the Wallpaper Design Awards 2018



Winner of the Focus Gold Award 2018 for outstanding design quality



Winner of the Muuuz International Award 2018 in the furniture category



Winner of the FX Design Awards, Lighting Product 2017



e-Elements

1 e-Lights

Dimmable, available in
– Warm white
2700 Kelvin
– Cold white
5700 Kelvin
Both with or without the “light at compartment opening” function.

2 e-USB Charger

Provides a voltage of 5 volts to the connected device. (Capacity: 6.5 W)

3 e-Dummy

Sleek, black e-Dummy element close recesses that are still unutilised. If a piece of furniture should later be supplemented with additional light, using e-Tubes (consuming), which are first equipped with e-Dummy elements, is recommended.

4 e-Tube (power outlet)

Tubes with recesses for e-Lights, e-USB chargers or e-Dummy elements that can be easily snapped into place or replaced.

L 350, 1 recess
L 500, 2 recesses
L 750, 3 recesses

5 e-Tube (conductive)

The conductive e-Tube serves to conduct the electricity if no inserts are desired in this location. It is available in lengths of 750, 500, 395, 350, 250 and 175 mm.

6 e-Ball, e-Connector

To enable the flow of electricity, the ball and connector were refined. The exterior dimensions remain unchanged. The distinguishing feature of the ball is the black insulation ring.

7 e-Power Supply

Includes dimmer at the operating switch. Transforms the power supply voltage to 24 volts. (Capacity: 60 W)



Engineered & Made in Switzerland.

Only available in certain countries. Please contact USM Switzerland for availability in your country.



USM Haller Table

Designed more than 50 years ago, the USM Haller Table still embodies timeless elegance. Its clean lines perfectly harmonise with the modular furniture system of the same name.

For home office use, the classic USM Haller Table is easily equipped with smart accessories and an optional cable basket as well as integrated solutions for electrification.

Basic table

Optional cable basket underneath the tabletop



USM Haller Classic

H: 740
L: 3000 / D: 1000
L: 3000 / D: 750
L: 2500 / D: 1000
L: 2500 / D: 750
L: 2250 / D: 1000
L: 2250 / D: 750
L: 1000 / D: 1000
L: 750 / D: 750

H: 740 or 680–860*
L: 2000 / D: 1000
L: 2000 / D: 750
L: 1750 / D: 1000
L: 1750 / D: 750
L: 1500 / D: 1000
L: 1500 / D: 750
L: 1250 / D: 750

Sliding tabletop + adaptation points

Integrated cable tray accessible from above by sliding back the tabletop
Adaptation points for accessories



USM Haller Advanced

H: 740 or 680–860*
L: 2000 / D: 1000
L: 2000 / D: 750
L: 1750 / D: 1000
L: 1750 / D: 750
L: 1500 / D: 1000
L: 1500 / D: 750
L: 1250 / D: 750

Working desk

Optional cable basket underneath the tabletop
Removable adaptation points for accessories



USM Haller Plus

H: 740
L: 3000 / D: 1000
L: 3000 / D: 750

H: 740 or 680–860*
L: 2000 / D: 1000
L: 2000 / D: 750
L: 1750 / D: 1000
L: 1750 / D: 750
L: 1500 / D: 1000
L: 1500 / D: 750
L: 1250 / D: 750

Occasional table



USM Haller occasional table, square

H: 370
L: 3000 / D: 1000
L: 3000 / D: 750
L: 2500 / D: 1000
L: 2500 / D: 750
L: 2250 / D: 1000
L: 2250 / D: 750
L: 2000 / D: 1000
L: 2000 / D: 750
L: 1750 / D: 1000
L: 1750 / D: 750
L: 1500 / D: 1000
L: 1500 / D: 750
L: 1250 / D: 750
L: 1000 / D: 1000
L: 750 / D: 750

*Manual height adjustment with a removable handle.
All measurements in mm.

Accessories
for all USM Haller Desks

- 1 **Grommet hatch for network access**
Flush hinged cover set into the tabletop for easy network access, can be positioned at two different locations.
- 2 **Cable management**
For the Advanced table type, a cable tray integrated under the tabletop offers storage room and attachment options for all cables and technical components.
For the traditional USM Haller Table and the USM Haller Plus, a cable basket can be attached.
- 3 **CPU holder**
Computers in various sizes can be mounted using a simple holding device under the table.
- 4 **Link chain**
Holds and directs cables to the power source. Flexible and adjustable to various lengths.
- 5 **Power strip**
Can be configured individually for data and power supply according to country-specific requirements. Available with a 4 m cable. Magnetically fixed in the cable tray.
- 6 **Flat screen pivot arm**
Screens are screwed to the height adjustable pivot arm using a mounting plate (VESA standard). Available for USM Haller classic desk: The pivot arm can be mounted onto the table edges with the universal holder or into the table leg using an assembly tube. Available for USM Haller Plus and Advanced: The bracket can be connected directly to one of the adaptation points.
- Options
6a **Mounting at different heights**
is possible for screens weighing up to 12 kg.
6b **Continuous height adjustment**
for screens weighing up to 12 kg.

Cable duct

The classic USM Haller table can be updated with a black aluminum cable duct section, with lids that fold open on both sides, to integrate power strips (5) and cables. This enables the table depths to be expanded to the EU standard of more than 800 mm. For table heights of 2000, 1750, 1500, 1250, 1000, 900, 750.

Accessories
for USM Haller Desk Plus/ Advanced

- 7 **Front and side panel**
A black mesh fabric can be attached to the back or the side under the table frame. Available for the following table lengths: 2000, 1750, 1500, 1250, 1000, 750 and depths: 1000, 750.
- 8 **Material tray**
Provides room for writing instruments and can be discreetly stowed under the tabletop.
- 9 **USM Privacy Panels**
Can be attached to the long side to ensure individuality and privacy for people working at tables configured as a block station. H: 350 or 700. Available for the following table lengths: 3000, 2500, 2250, 2000, 1750, 1500, 1250*
*only for Haller tables without Adaptation points
- 10 **Flat screen support bar**
The bracket is inserted into the adaptation points. Up to two screens (max. 2 x 12 kg) can be attached using a mounting plate (VESA standard). Screens can be mounted at different heights; screens can be adjusted with ball joints.
- Options
10a **Flat screen support bar fix**
10b **Flat screen support bar adjustable**
Move forwards or backwards 2 notches at a time to adjust the viewing distance.
- 11 **USB adapter**
The adapter is suitable for USB 2.0 and 3.0 ports; it can easily be inserted into the adaptation point. Usable as power supply or for data transfer.
- 12 **Lamp peg**
An optional lamp peg for easy attachment of traditional table lamps. Electrification is possible through the adaptation point.

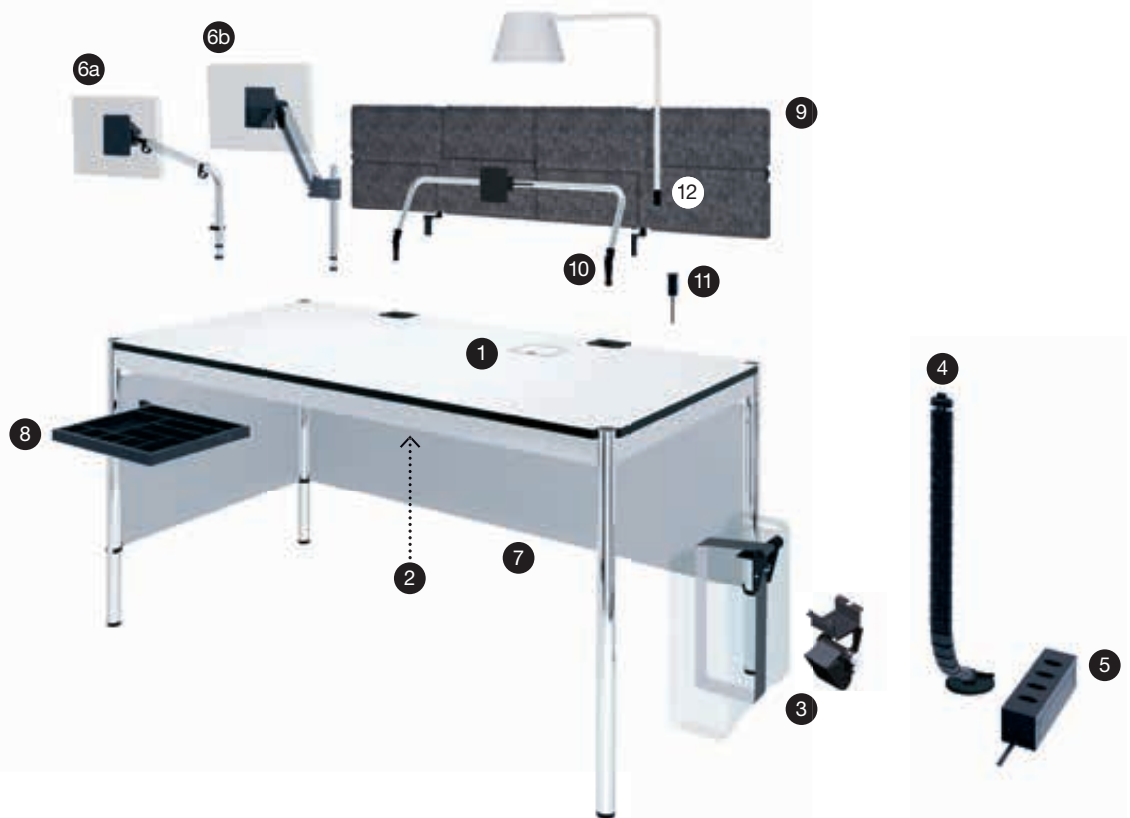

USM Kitos M and E Desk

Each desk (except free-standing) of the USM Kitos M and E family offers integrated smart solutions for electrification.

Why USM Kitos M?

The "M" in its name stands for mechanical spring-loaded height adjustment; adjustment time approx. 1 sec. with zero energy consumption. This system is more than 10 times faster than the electronic equivalent and has an extremely long operating life.

Why USM Kitos E?

Maximum functionality and captivating design – USM Kitos E unites all requirements in one modern workplace: continuous height adjustability and maximum stability. A distinction is made between fixed and motor-driven legs in the E1, E2 and E3 models.

E1



H: 740
With or without middle traverse

E2 with 1 motor



H: 700–1200
Adjustment time approx. 30 sec.
With middle traverse

E3 with 2 motors



H: 650–1300
Adjustment time approx. 20 sec.
With middle traverse

Basic desk

Integrated cable tray underneath the tabletop



USM Kitos M

H: 700–1200
L: 1800 / D: 900
L: 1750 / D: 750
L: 1600 / D: 800

USM Kitos E

L: 1800 / D: 900
L: 1750 / D: 750
L: 1600 / D: 800
Available with E1*, E2 or E3** columns

Sliding tabletop

Integrated cable tray accessible from above by sliding back the tabletop

Adaptation points for accessories



USM Kitos M Plus

H: 700–1200
L: 1800 / D: 900
L: 1750 / D: 750
L: 1600 / D: 800

USM Kitos E Plus

L: 1800 / D: 900
L: 1750 / D: 750
L: 1600 / D: 800
Available with E1*, E2 or E3 columns

Extra size

Integrated cable tray underneath the tabletop and accessible from all sides



USM Kitos M Meeting

H: 700–1150
L: 2500 / D: 1000
L: 2250 / D: 1000

USM Kitos E Meeting

L: 2500 / D: 1250
L: 2500 / D: 1000
L: 2250 / D: 1000
Available with E1, E2 or E3 columns

Side table



USM Kitos E Free-standing

H: 740 or 700 – 1110
Square
L: 750 and 900
Round
Ø: 900 and 1100

* Available with or without middle traverse.

**Available in a GS-Mark tested version with 3 mm table edge radius and the asymmetrical middle traverse.

The table can also be provided with an asymmetrical version of the middle traverse, for extra legroom. (This is not possible with the USM Kitos E / M Meeting.)

All measurements in mm.

Accessories

for all USM Kitos M and E Desks

- 1 **Grommet hatch for network access**
Flush hinged cover set into the tabletop for easy network access, can be positioned at two different locations.
- 2 **CPU holder**
Computers in various sizes can either be mounted using a simple holding device under the height-adjustable tabletop or attached to the table column.
- 3 **Link chain**
Holds and directs cables to the power source. Flexible and adjustable to various lengths.
- 4 **Power strip**
Can be configured individually for data and power supply according to country-specific requirements. Available with a 4 m cable. Magnetically fixed in the cable tray.
- 5 **USM Privacy Panels**
Can be attached to the long side to ensure individuality and privacy for people working at tables configured as a block station. H: 350 or 700. Available for the following table sizes: 2500, 2250, 1800, 1750, 1600.

Accessories

for all USM Kitos M and E Desks, except USM Kitos M Meeting/ E Meeting

- 6 **Flat screen pivot arm**
Screens are screwed to the height adjustable pivot arm using a mounting plate (VESA standard). Available for USM Kitos E/M desk: The pivot arm can be mounted onto the table edges with the universal holder. Available for USM Kitos M and E Plus: The bracket can be connected directly to one of the adaptation points.
- Options
- 6a **Mounting at different heights**
is possible for screens weighing up to 12 kg.
- 6b **Continuous height adjustment**
for screens weighing up to 12 kg.
- 7 **Front panel**
A black mesh fabric attaches to the front under the tabletop. Available for the following table sizes: 1800, 1750, 1600.
- 8 **Material tray**
Provides room for writing instruments and can be discreetly stowed under the table

Accessories

for USM Kitos M Plus / E Plus

- 9 **Flat screen support bar**
The bracket is inserted into the adaptation points. Up to two screens (max. 2 x 12 kg) can be attached using a mounting plate (VESA standard). Screens can be mounted at different heights; screens can be adjusted with ball joints.
- Options
- 9a **Flat screen support bar fix**
- 9b **Flat screen support bar adjustable**
Move forwards or backwards 2 notches at a time to adjust the viewing distance.
- 10 **USB adapter**
The adapter is suitable for USB 2.0 and 3.0 ports. It can be inserted easily into the adaptation point. Usable as power supply or for data transfer.
- 11 **Lamp peg**
An optional lamp peg for easy attachment of traditional table lamps. Electrification is possible through the adaptation point.

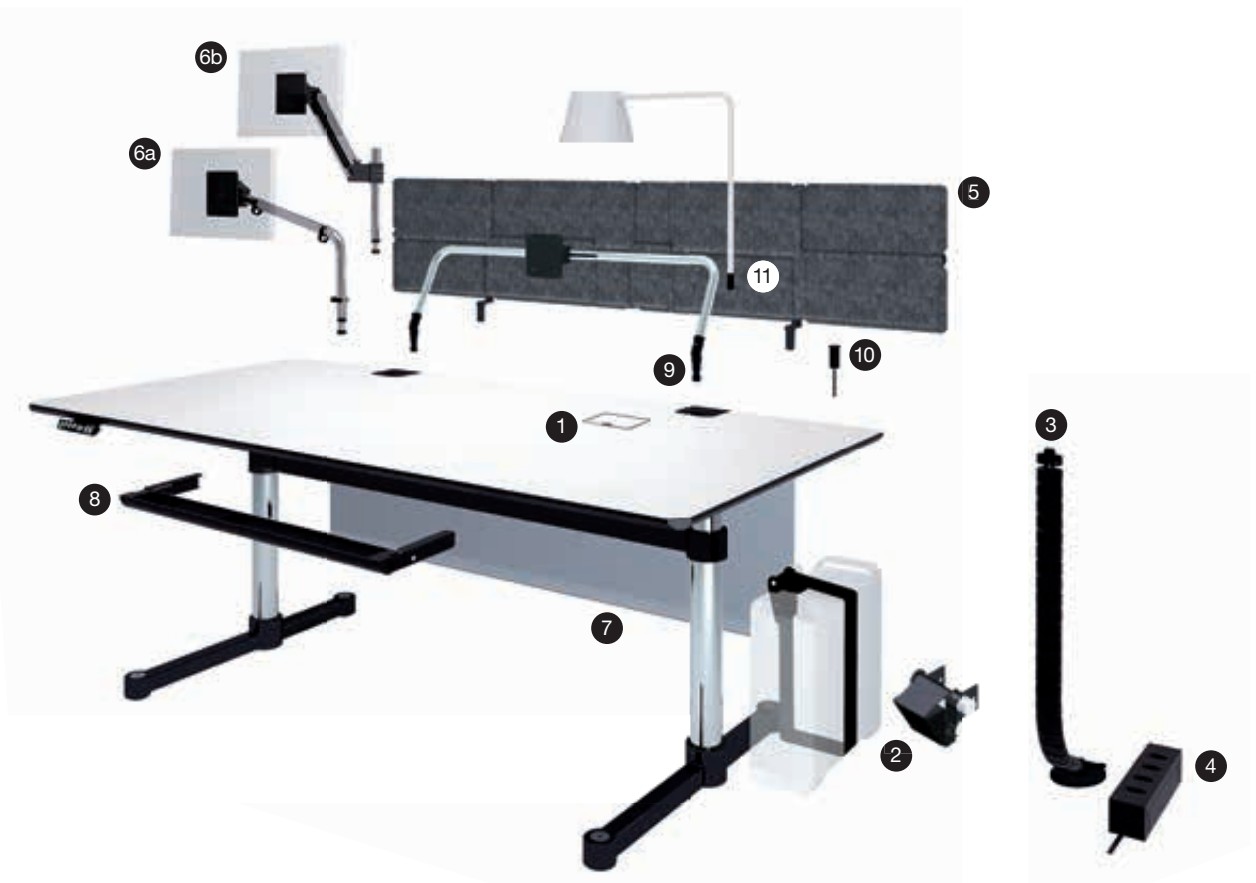

Accessories



1

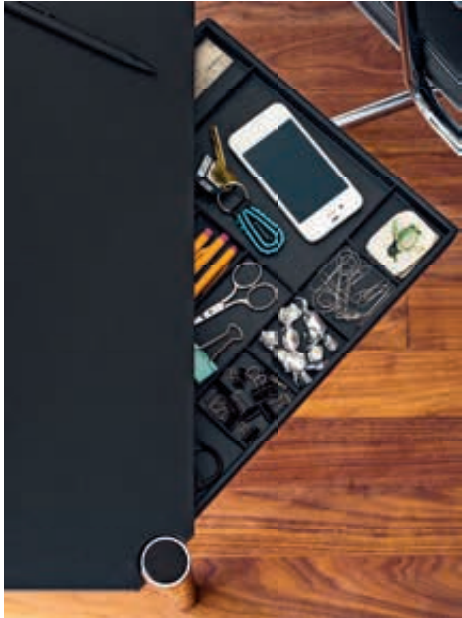

2



3



4

1 **Metal, magnetic bookend**
Available in light gray and graphite black.

2 **Material tray**
Provides room for writing instruments and can be discreetly stowed under the tabletop.

3 **USM Inos internal organisation**
Plastic box in metal frame:
Perfect for keeping small bits and pieces organized – be it in your home office or anywhere else in your house.

4 **USM Inos C4 box set**
Available in light gray or graphite black, open or closed, with five or ten drawers: measurements of the Inos box set perfectly fit all USM Haller furniture.

5 **USM Inos Box**
The new USM Inos Boxes organise, store and protect both your treasures and everyday paraphernalia of life. Several boxes can be stacked on top of each other with the help of trays, which can also be used as covers or serving trays, or to hold assorted small items around the home. These soft storage boxes made of nonwoven polyester are available in four different sizes and in light gray and anthracite gray.

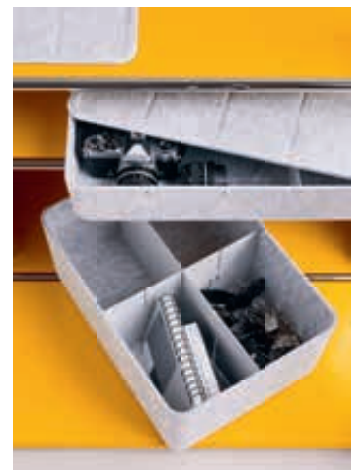

5

Colors & surfaces

USM Haller



Metal



Pure white
RAL 9010



Light gray
RAL 7035



USM matte silver



Mid-gray
RAL 7005



Anthracite
RAL 7016



Graphite black
RAL 9011



Steel blue
RAL 5011



Gentian blue
RAL 5010



USM green



Golden yellow
RAL 1004



Pure orange
RAL 2004



USM ruby red



USM brown



USM beige

USM Haller and USM Kitos Tables



Powder-coated MDF



Pure white
RAL 9010

Back-lacquered clear glass



Pure white
RAL 9010



Light gray
RAL 7035



USM matte silver



Mid-gray
RAL 7005



Anthracite
RAL 7016



Graphite black
RAL 9011



Steel blue
RAL 5011



Gentian blue
RAL 5010



USM green



Golden yellow
RAL 1004



Pure orange
RAL 2004



USM ruby red



USM brown



USM beige

Back-lacquered etched glass



Pure white
RAL 9010



Light gray
RAL 7035



Mid-gray
RAL 7005



Anthracite
RAL 7016



Graphite black
RAL 9011



Steel blue
RAL 5011

Transparent glass



Transparent glass

Other colors and surfaces available upon request. Prices and delivery times of table surfaces upon request.

The tabletops in glass are only available for USM Haller Desks up to L: 2000 mm and all USM Kitos Desks with a fixed height (H: 740 mm) or stepwise height adjustment and continuous height adjustment (H: 680–780 / 1060 mm).

Linoleum



Ash linoleum



Charcoal linoleum



Black linoleum



Pebble linoleum



Mauve linoleum

Laminate

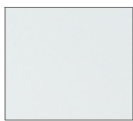

Pearl gray laminate



Pastel gray laminate



Light mid-gray laminate



Dark warm gray laminate

Oiled or lacquered veneer



White oiled oak veneer



Natural oiled oak veneer



Brown oiled oak veneer



Natural lacquered oak veneer



Natural lacquered beech veneer



Black lacquered oak veneer

Details

USM Haller



Metal

USM Haller Table



Powder-coated MDF

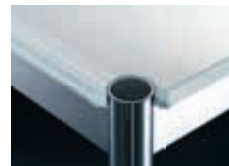

Back-lacquered clear glass

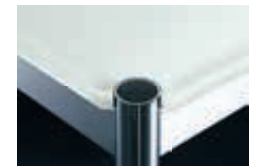

Back-lacquered etched glass

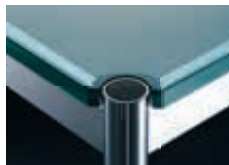

Transparent glass

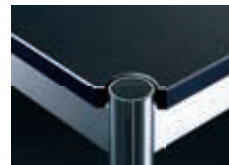

Linoleum



Laminate



Oiled or lacquered veneer

USM Kitos Table



Powder-coated MDF



Back-lacquered clear glass



Back-lacquered etched glass



Transparent glass



Linoleum



Laminate



Oiled or lacquered veneer

Switzerland

USM U. Schärer Söhne AG
Thunstrasse 55, 3110 Münsingen
Phone +41 31 720 72 72, info.ch@usm.com

Germany

USM U. Schärer Söhne GmbH
Siemensstraße 4a, 77815 Bühl
Phone +49 7223 80 94 0, info.de@usm.com

France

USM U. Schärer Fils SA, Showroom
23, rue de Bourgogne, 75007 Paris
Phone +33 1 53 59 30 37, info.fr@usm.com

United Kingdom

USM U. Schaerer Sons Ltd., London Showroom
Ground Floor, 49–51 Central St., London, EC1V 8AB
Phone +44 207 183 3470, info.uk@usm.com

USA

USM U. Schaerer Sons Inc., New York Showroom
28–30 Greene Street, New York, NY 10013
Phone +1 212 371 1230, info.us@usm.com

Japan

USM U. Schaerer Sons K.K., Tokyo Showroom
Marunouchi MY PLAZA 1 · 2F
2-1-1 Marunouchi, Chiyoda-ku, Tokyo 100-0005
Phone +81 3 5220 2221, info.jp@usm.com

All other countries
contact USM Switzerland.

www.usm.com

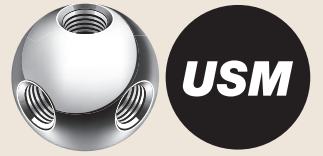

Make it your

Work space



Collaboration

- 4 Co-working benches
- 8 Shared workstations
- 12 Meeting

Social

- 16 Welcome
- 20 Getting together
- 24 Lounge
- 28 Cafeteria
- 32 Relax

Focus

- 36 Creative zone
- 40 Creative space
- 44 Multiple workstations
- 48 Individual workstations
- 56 Executive offices
- 60 Ergonomic offices

The USM world

- 64 Strong core values
- 66 Product information
- 78 Colors & surfaces

New ways of living and collaborating have especially affected the way workplaces are designed and furnished today – and the workplace will be subject to further change in the near future.

The traditional individual workstation has become one of many. The contemporary office world is open: modifiable arrangements are more and more essential for meeting today's requirements of constant communication, well-being and flexibility in thinking, acting and collaborating.

These times perfectly suit USM. Modularity, versatility and quality have always been associated with USM: our wide range of modular elements, of adaptable office furniture, helps you design a workspace that conforms exactly to your coworkers' individual needs and the overall demands of your company today and in the future – creating a setting where you, your employees and teams feel comfortable and empowered to tap their full creative potential.

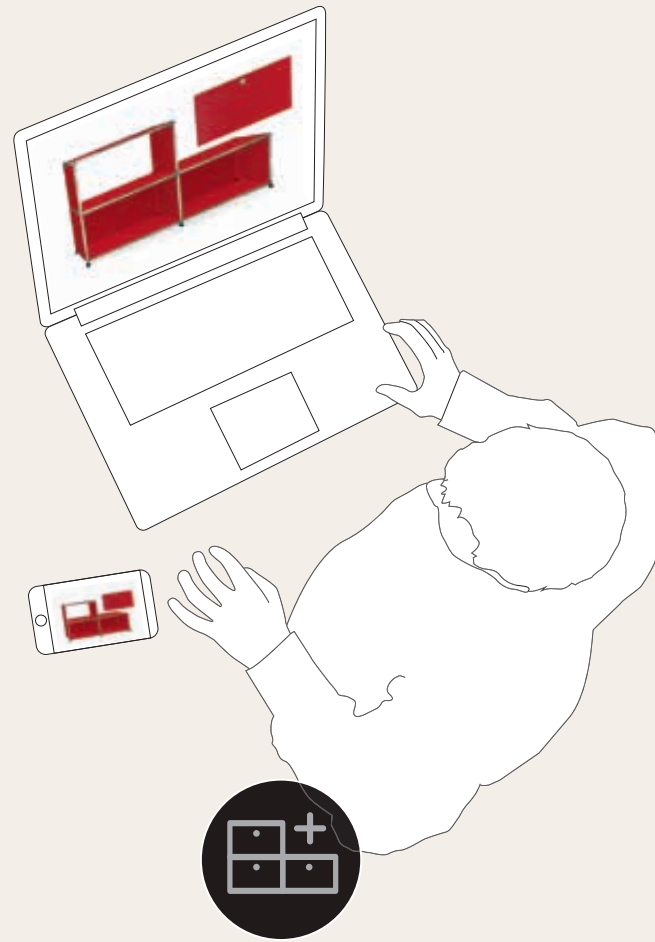

Online Configurator
Design your individual piece of USM online!

Customized Service
Visit a USM Showroom or one of our 400 international sales partners worldwide for individual support. Find your closest USM professional online.

www.usm.com



TUESDAY

PROS

→ OUR FUTURE TRENDS

MARKET

→ THE FUTURE OF BUSINESS

MINER

LIFE OF OUR DATA SHOULD BE TALK

GROUP STANCE

Trust

Summary

Central

Diversity

... (many other sticky notes)

A glimpse into the future of work



Ben van Berkel – Founder of UNStudio



Ren Yee – Head of Innovation
Strategy & Forecasting

Over the past year USM has collaborated with the UNStudio Futures team to explore the spatial implications of work in the future. Today we can't even imagine the jobs that will exist in 2030.

Organ designer, Cybernetic director, Drone experience officer. How will our work change, and what kind of spaces will we need?

We began tackling these questions at our booth at Salone del Mobile 2018 – Home-Work. The design illustrated the merging of home and work environments which results from digital devices, platformisation and the emergence of a planetary labour market. We won two Frame awards, energizing us to dig deeper into the topic through scenario-building PlayLabs, where participants unpacked the hopes and fears which pervade conversations about the future.

So how has work changed over the past 50 years? Our beloved devices were meant to lessen our workload and increase our leisure time by allowing us to work anywhere, anytime. In reality we've ended up working everywhere, all the time. Fundamentally, our interaction with computers hasn't changed since they were invented – we stare at a screen and watch information move around on it.

What if we were no longer tethered to a desk? We forecast a more playful future for work. Business is moving from a long period where analytical skills were valued highest in the search for efficiency, to one where creative skills become essential to deal with complexity, volatility, and the requirements for constant innovation. In the future we will all need to be designers.

How should workspace respond?

The next revolution in office design will release us from our desks and allow us to use our whole bodies at work.

Personal voice assistants will guide our work and screens will be replaced by conversation, gesture and light. Extended Reality (XR) spaces will allow us to literally pull information around in physical space, from one side of a room to another.

At the same time, our persistent desire for collectivity calls for discrete environments which signal what type of interaction they are open for – from focus to one-to-one to collaboration – as well as what level of technology they contain. Some will be tech-free zones where texture and tactility win out, allowing us to display our personality and build collective identity. Eventually, tech and tactility will integrate. We'll immerse ourselves in nature, growing food with indoor hydroponic systems or taking our work out into nature using Augmented Reality to build on real-world experiences.

Ben van Berkel,
Ren Yee



Collaboration

Co-working benches





Collaboration



Plug and play
Via small cable ports
in each table, your
laptops, smartphones
and other tools easily
connect to electrical
and communication
networks. Just plug in
and keep working.



Team spirit

- 1.0 Get together at one large desk: USM Haller Plus three-meter-long desks in golden yellow powder-coated MDF create a colorful and inspiring shared workstation in the modern co-working space – including adaptation points for various smart accessories such as lamps, USBs, and flat screen support bars.



Superdesk

- 2.0 Work methods vary, teams change size and composition. Your office layout adapts to your evolving needs and projects. USM Haller desks come in brown oiled-oak veneer and in various other colors, sizes, shapes and materials. Adding our pedestals maximizes space and agility.



Dividing space, connecting people

- 3.0 USM Haller combines various functions in one piece of furniture. Providing storage space and dividing rooms, it also works perfectly as a standing counter for ad-hoc team meetings – inspiration and variation unlimited. And it's all in gentian blue, bringing a welcome dash of color to your workspace.

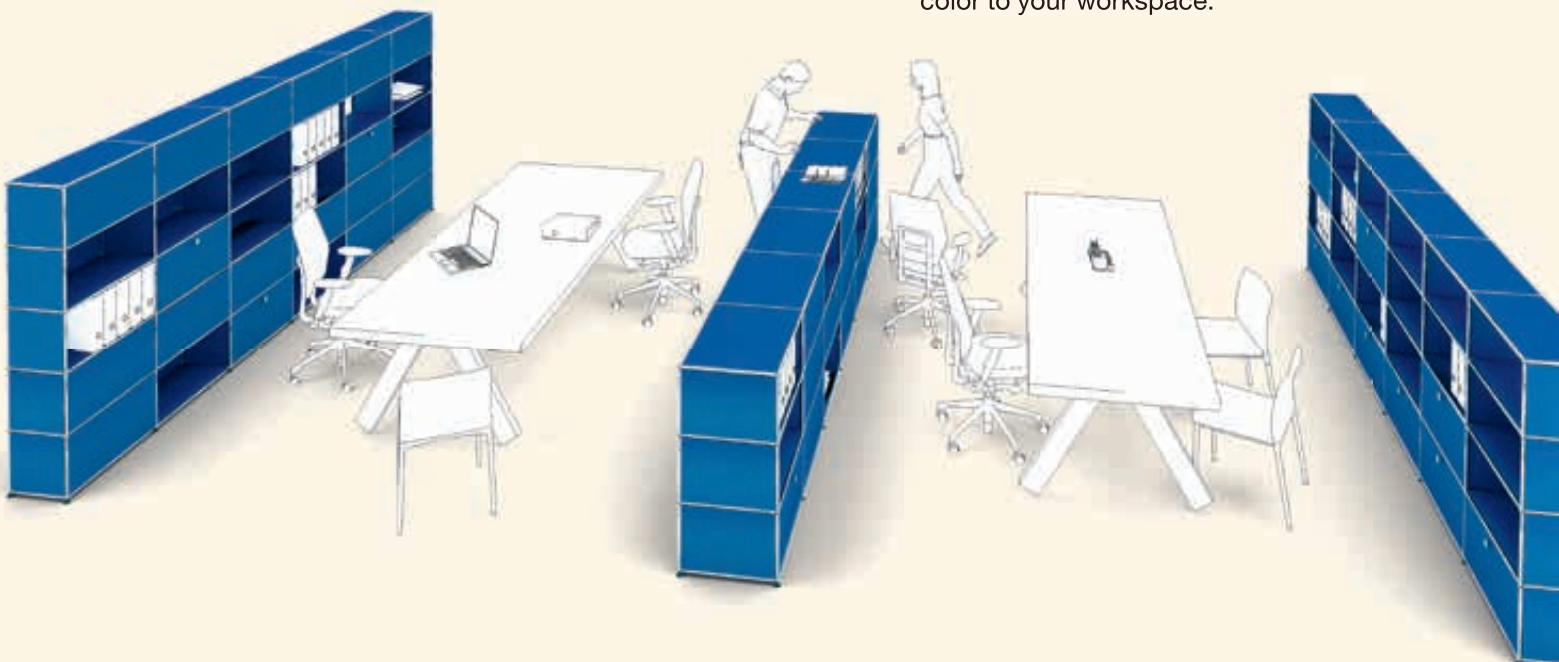

Collaboration

Shared workstations





Collaboration

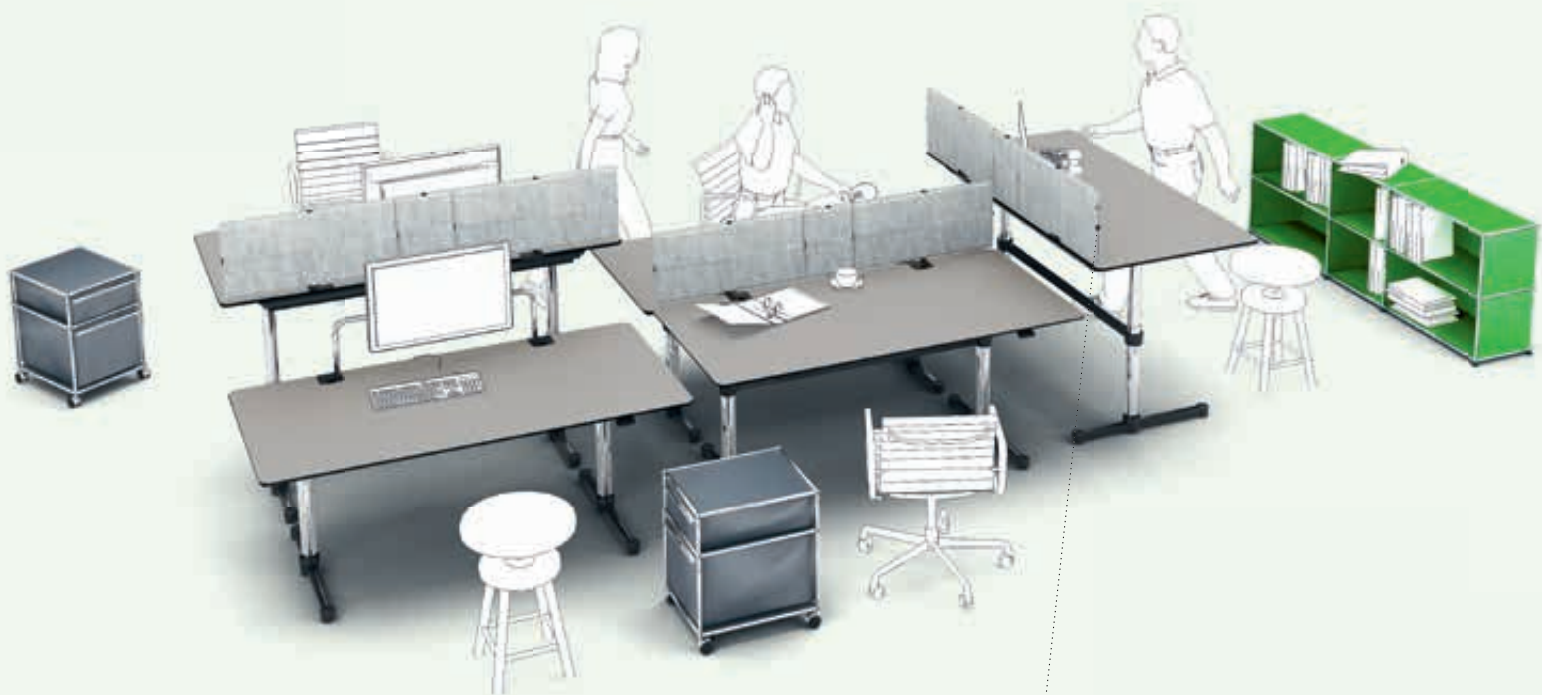

Agility, collaboration

4.0 Five height-adjustable USM Kitos M Plus desks in light mid-gray laminate build one agile workstation – enabling a quick change from one desk to another, sharing work on a common project.

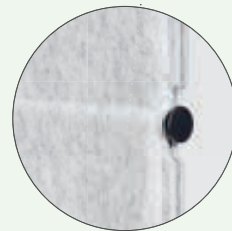

Sound absorption and privacy
Ensure privacy and optimize acoustics in the shared workstation: USM Privacy Panels offer a modular solution that can be quickly positioned and removed according to situational needs.



The new adjustable flat screen support bar; move forward or backward – two notches at a time to adjust the viewing distance.

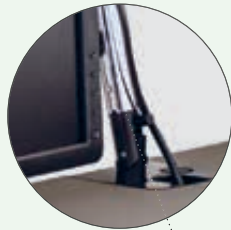

Hot desking

5.0 Modern shared workspace: six height-adjustable Kitos M Plus desks in warm dark gray laminate make six workstations. Several workers use one workstation on a rotating schedule – each with their own pure orange caddy holding their personal work material.

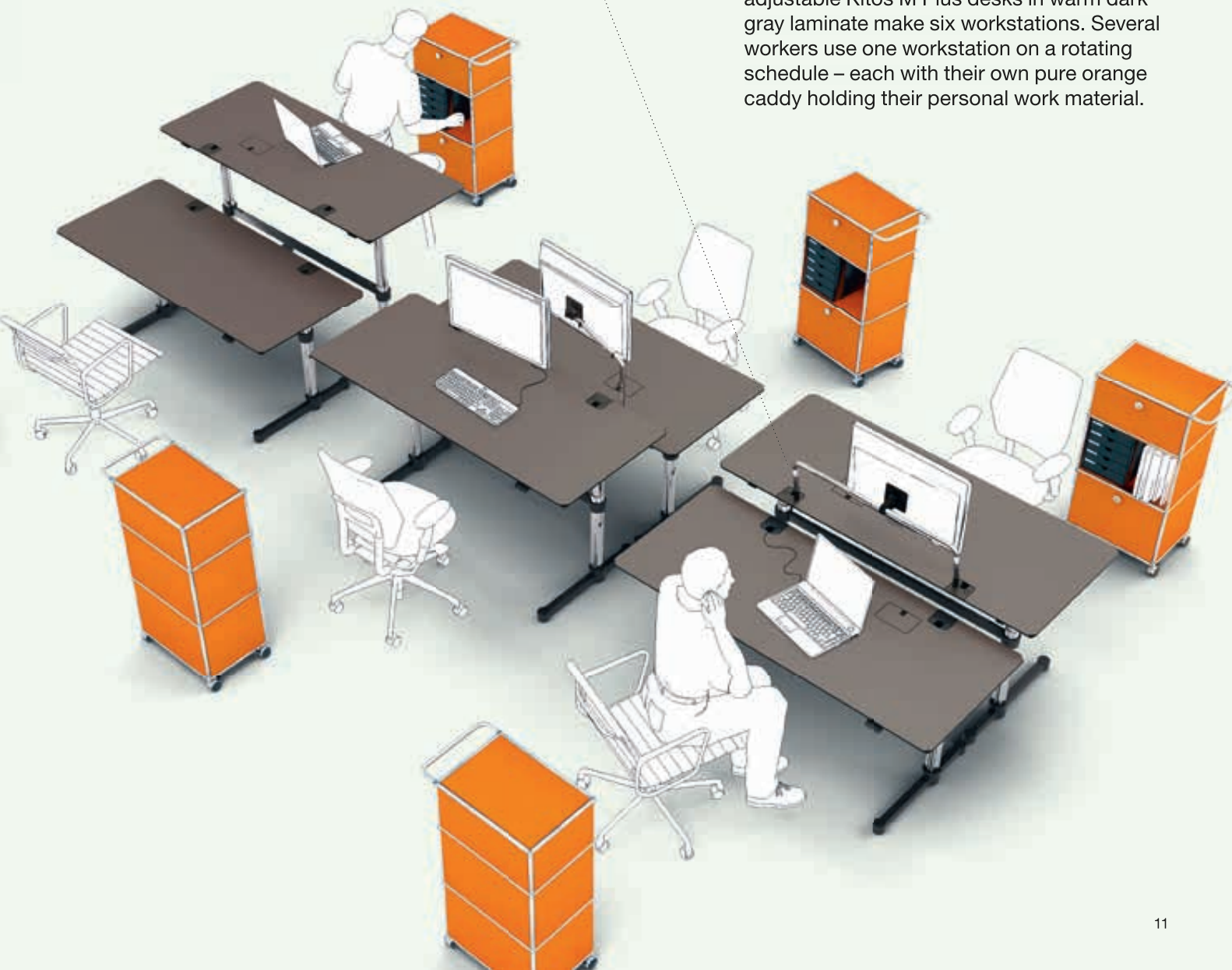

Collaboration

Meeting





Collaboration



Classic conference

6.0 Meeting at the highest level of style: the three-meter-long USM Haller table in white oiled-oak veneer creates an impressive figure in a simple environment – elegant, timeless, representative.

Sound absorption
Perforated metal panels with a fleece-covered interior: acoustic USM Haller elements significantly reduce background noise, thus improving the overall work environment.

Sophisticated storage

7.0 A vast amount of storage space: the classic USM Haller sideboard in matte silver is extremely useful and adds a sophisticated air to any meeting environment.



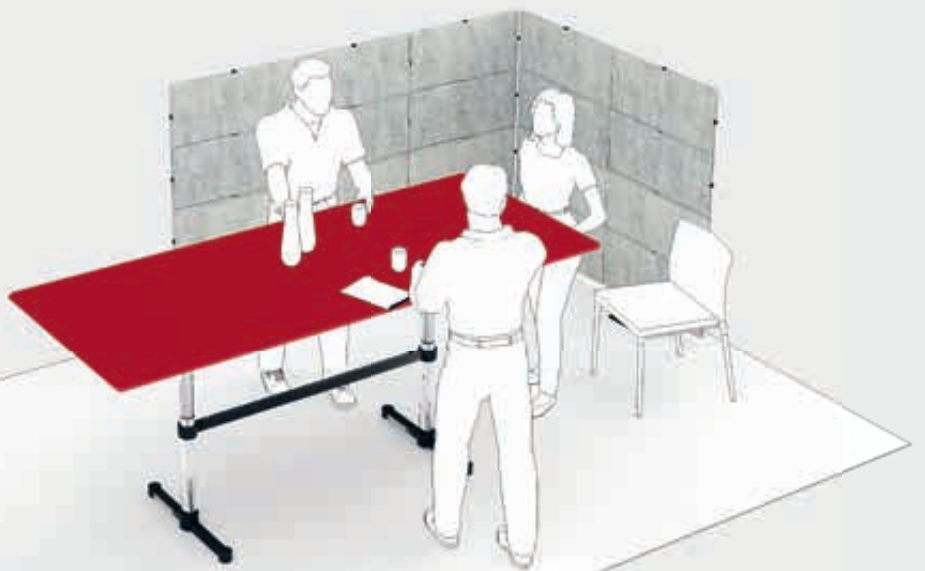

Dynamic meeting

- 8.0 A lot of space at a comfortable height: the USM Kitos M Meeting desk is made for ad-hoc stand-up meetings of up to eight people – Intuitively height adjusted in a moment.

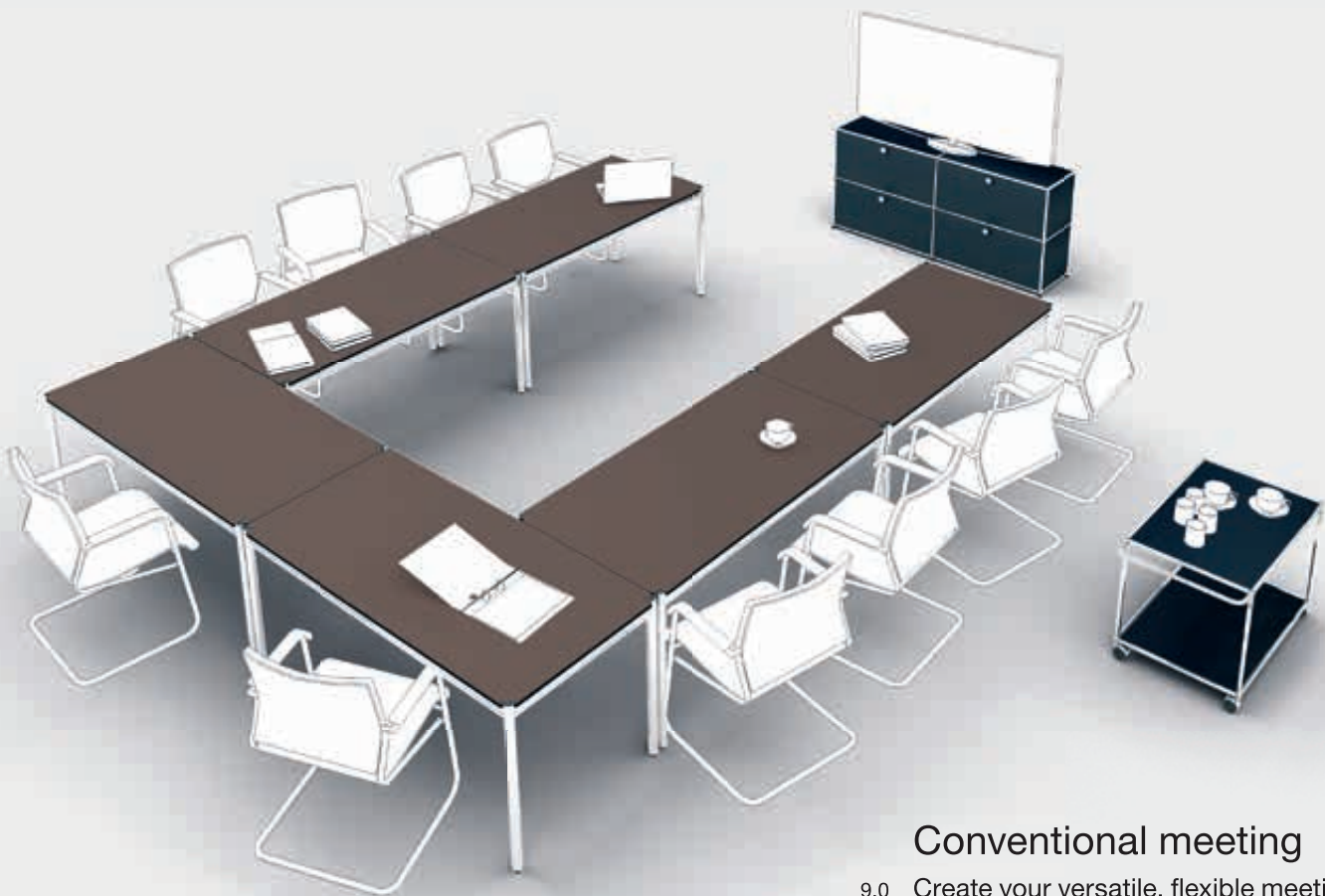

Conventional meeting

- 9.0 Create your versatile, flexible meeting room: all elements are quickly rearranged according to particular needs and conditions. Six USM Haller rectangular tables in mauve linoleum, a USM Haller serving cart and sideboard, both in graphite black, make the ideal layout for successful presentations, offering a clear view for everyone and enough space for technical equipment.

Social

Welcome





Social

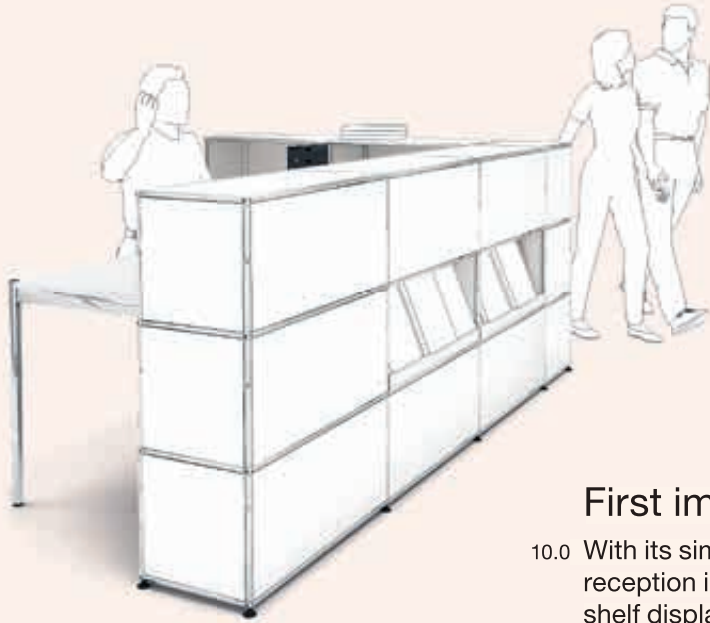

First impressions count

10.0 With its simple yet elegant face, the USM Haller reception in pure white, with a metal angled shelf displaying brochures and magazines, is a friendly and respectable greeting to visitors and business partners. Plus, it offers plenty of well-hidden storage space. The pure white powder-coated MDF USM Haller desk is a perfect, practical solution.

A warm welcome

11.0 The freestanding USM Haller highboard in pure orange marks a friendly spot in any office environment. At peak multifunctionality, it can be used as a greeting area, an information point or a docking station – placed and moved to wherever it fits.



Take a seat

- 12.0 The USM Haller reception unit is a visual cue to welcome visitors and to indicate where they should be in the building. It can be provided with guest seating, which is convenient if the reception area is also used for discussions or structured meetings.



Colorful islands
USM Privacy Panels
are available in a wide
range of different
colors. Adapt them
to your needs and
taste, easily remove
and reassemble them
as you like.

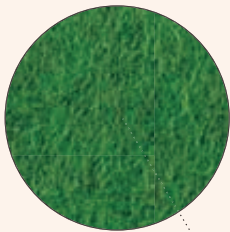

Waiting in style

- 13.0 With USM Privacy Panels, one quickly creates a private space within an open-plan reception. Add a comfortable sofa and a pure orange USM side table to set up an ideal waiting area, comfort zone or place of retreat.

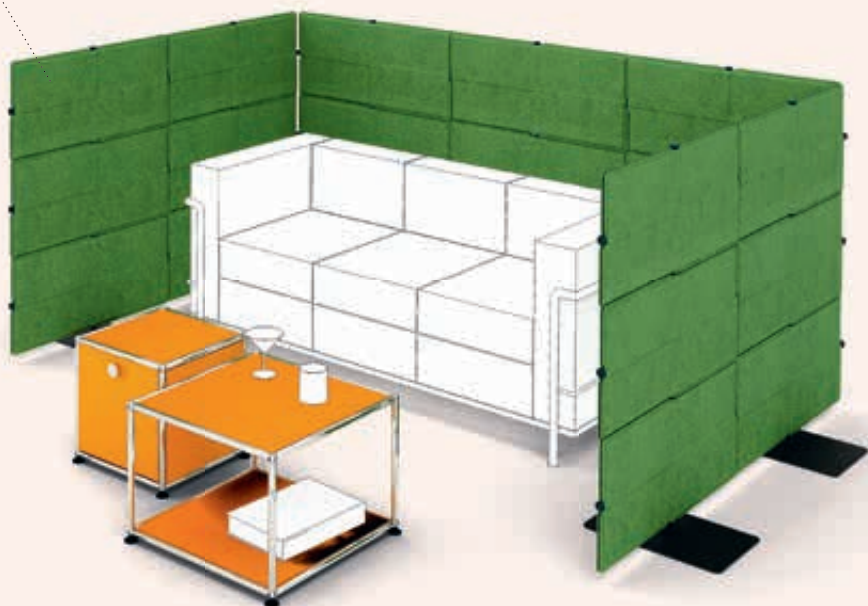

Social

Getting together





Social

Added storage value
Metal extension doors:
easy to open, conceal-
ing private storage.

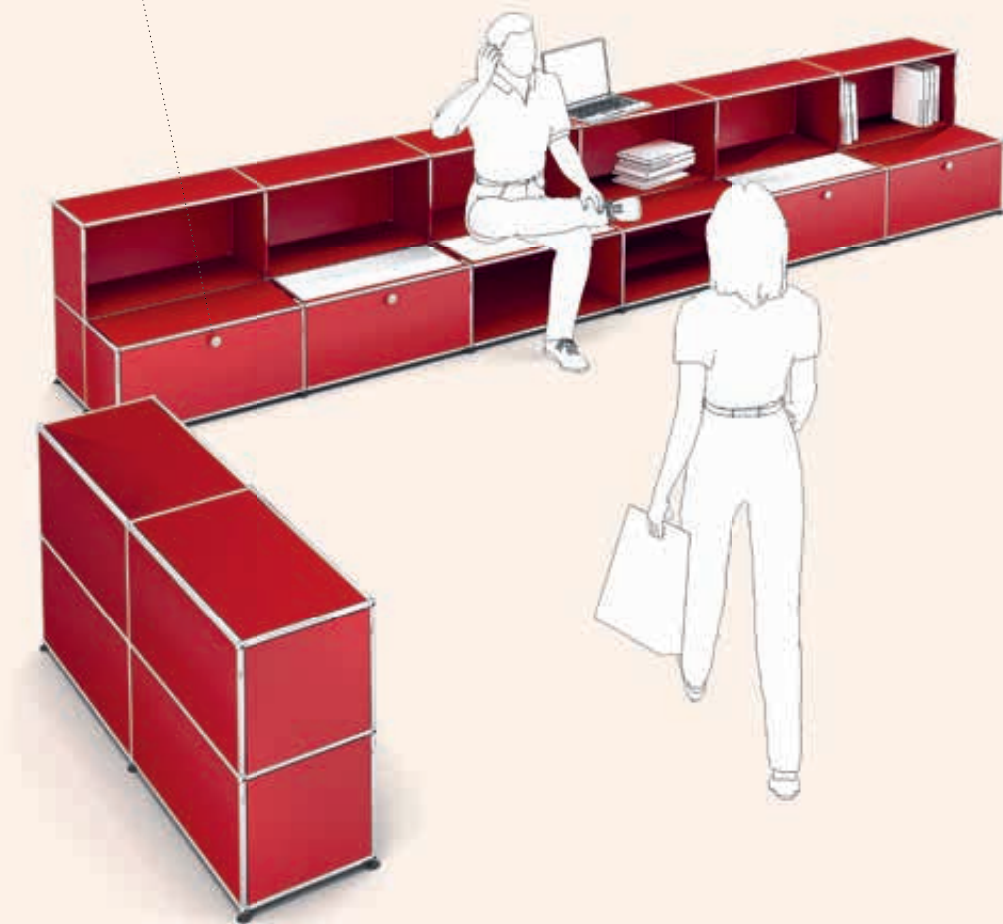
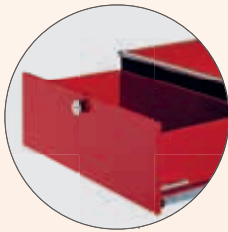

Office forum

14.0 The ruby red USM Haller bench provides a lot of storage. But it offers much more. With it, you can create your own office forum, a spot where you can take a break or conduct an informal meeting, with built-in storage for whatever the team needs at the ready.

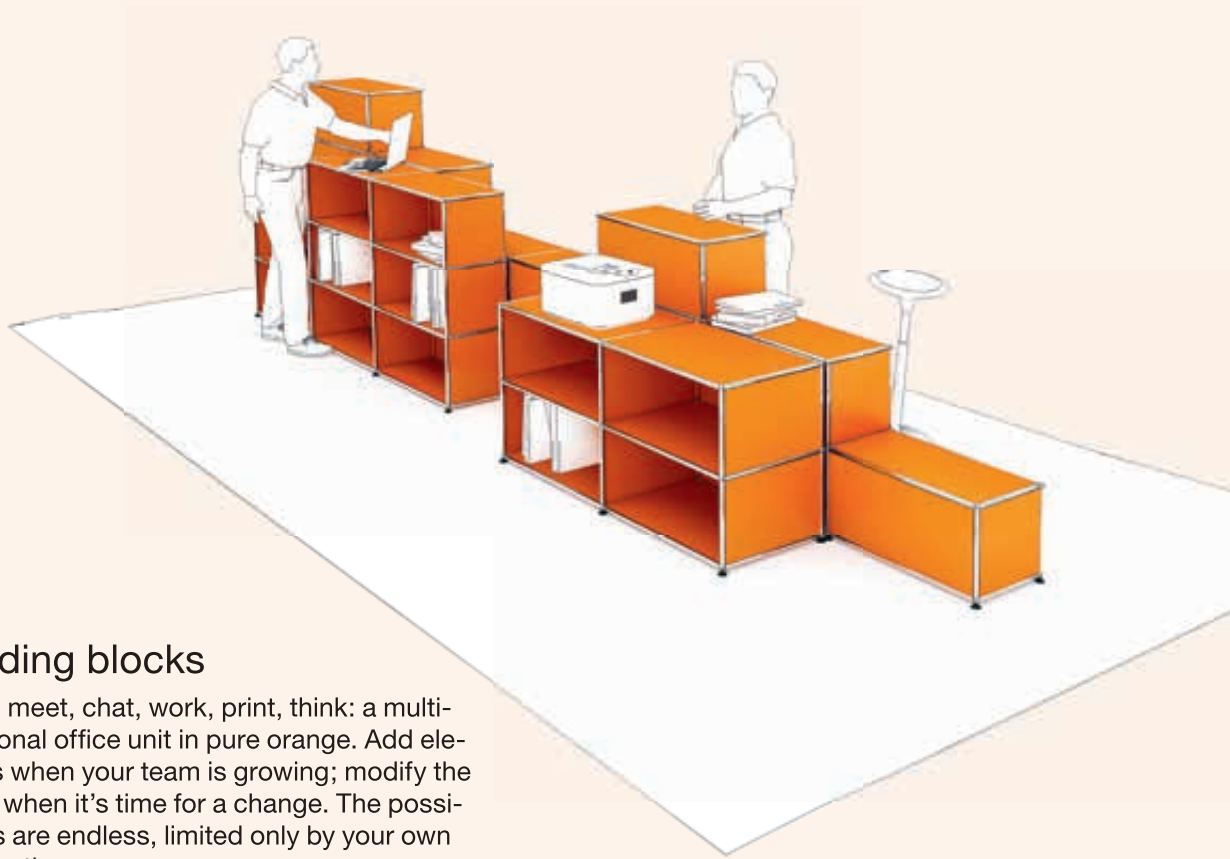

Building blocks

15.0 Store, meet, chat, work, print, think: a multi-functional office unit in pure orange. Add elements when your team is growing; modify the setup when it's time for a change. The possibilities are endless, limited only by your own imagination.



Get together

16.0 It's all about the perfect composition: the pure white multifunctional USM Haller units and the multicolored USM Privacy Panels – combine functions, colors, sizes and shapes into whatever communal area you want and need.

Social

Lounge





Social

Added storage value
Magnetic metal book-ends make a perfect match for a USM Haller bookshelf. Discover the full range of smart accessories on page 67.



A space to share

- 17.0 Create your own stylish island: take a beige USM Haller bookshelf with angled shelves as a magazine display and add a number of USM Haller side tables (for instance; beige, brown and pure white) in a playful yet elegant combination. Your perfect place to relax with colleagues.



Bookends
Another elegant solution for your bookcase. Discover the full range of smart accessories on page 67.

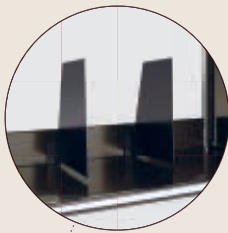

Open library

18.0 This is much more than an ordinary bookshelf: the brown USM Haller bookshelf is accessible from either side, it works as a semi-transparent room divider while providing space for a lot of books, of course. Additional functionality is provided by the brown side storage and the height-adjustable USM Kitos E freestanding round table in natural oiled-oak veneer.

Private areas

19.0 Bring coziness to your office to make you and your colleagues feel at home: USM Privacy Panels provide seclusion, USM Haller coffee tables in colorfully back-lacquered clear glass add a living-room touch and the pure white storage is an elegant extra.



Social

Cafeteria





Social

Snack bar

20.0 The green USM Haller unit is accessible from both sides. It is storage space and counter at once – and as such, the perfect office kitchen solution. More drawers, doors, dividing shelves and smart accessories can be added at any time.



Coffee time

21.0 A friendly place where colleagues gather for a quick lunch or coffee break: the light gray USM Haller counter with glass showcase – for small dishes, cakes or desserts – makes a great coffee bar in any work environment. Take a break!

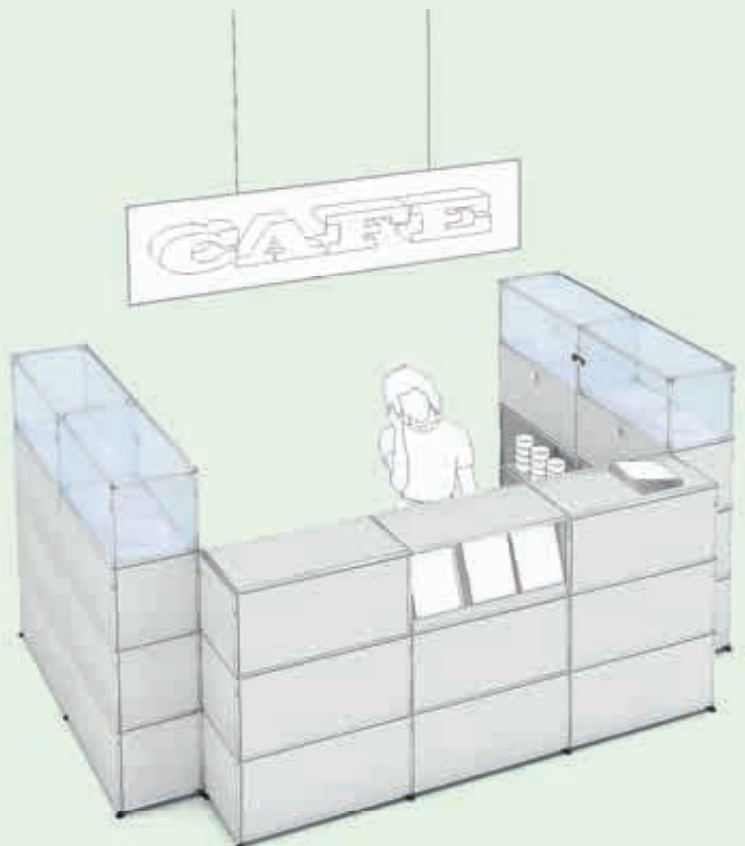

Height adjustment
Energy-saving, continuously height-adjustable, both in standing and in sitting positions.



Lunch break

22.0 Enjoy your meal at the office in a colorful, relaxing atmosphere – while sitting or standing. The freestanding height-adjustable square and round USM KITOS E tables are made of powder-coated MDF – and available in many different colors.

Social

Relax





Social

Multitasking

23.0 A multimedia library for the modern-day office becomes a social area to meet for a break or an informal meeting. And nothing is wanting: storage room, books and magazines, entertainment and communication devices are all on a USM Haller light gray and graphite black shelf with a wide variety of drawers, as well as drop-down and flip-up doors.



Classy comfort

24.0 Take a break in style: with its elegant design, the beige USM Haller sideboard with glass displays combines perfectly with sophisticated furniture and accessories. Enjoy your time with timeless design!

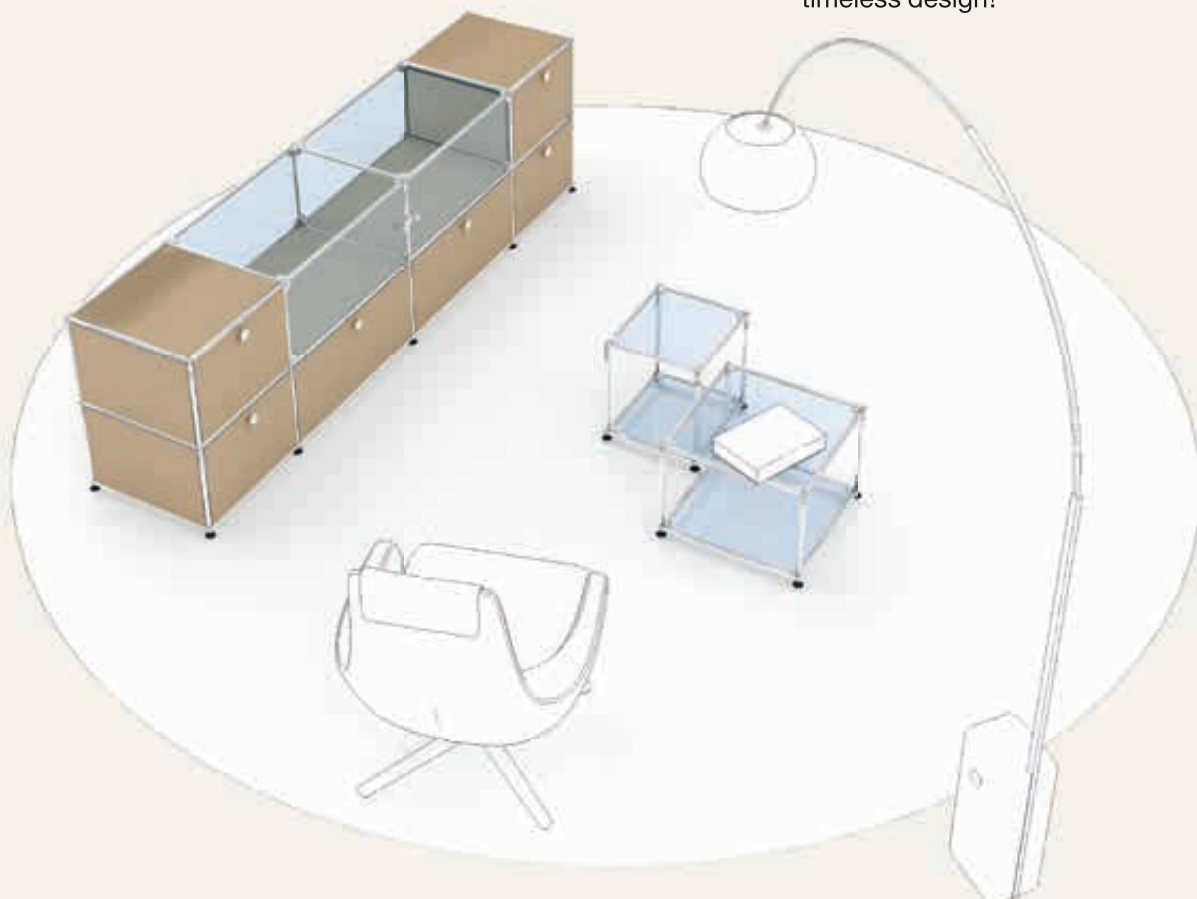

Versatility
Spherical connectors,
tubes and panels –
it's child's play to com-
bine these elements
to build the furniture
of your choice. You can
do it online too, with the
aid of the Configurator!
www.usm.com.

Game arena

25.0 Feel free to lay back and relax for a while – even at work. The modern workplace offers room to unwind, socialize and play games. And it doesn't take much to create it. Arrange some small green USM Haller storage units and side tables in a free-spirited way.

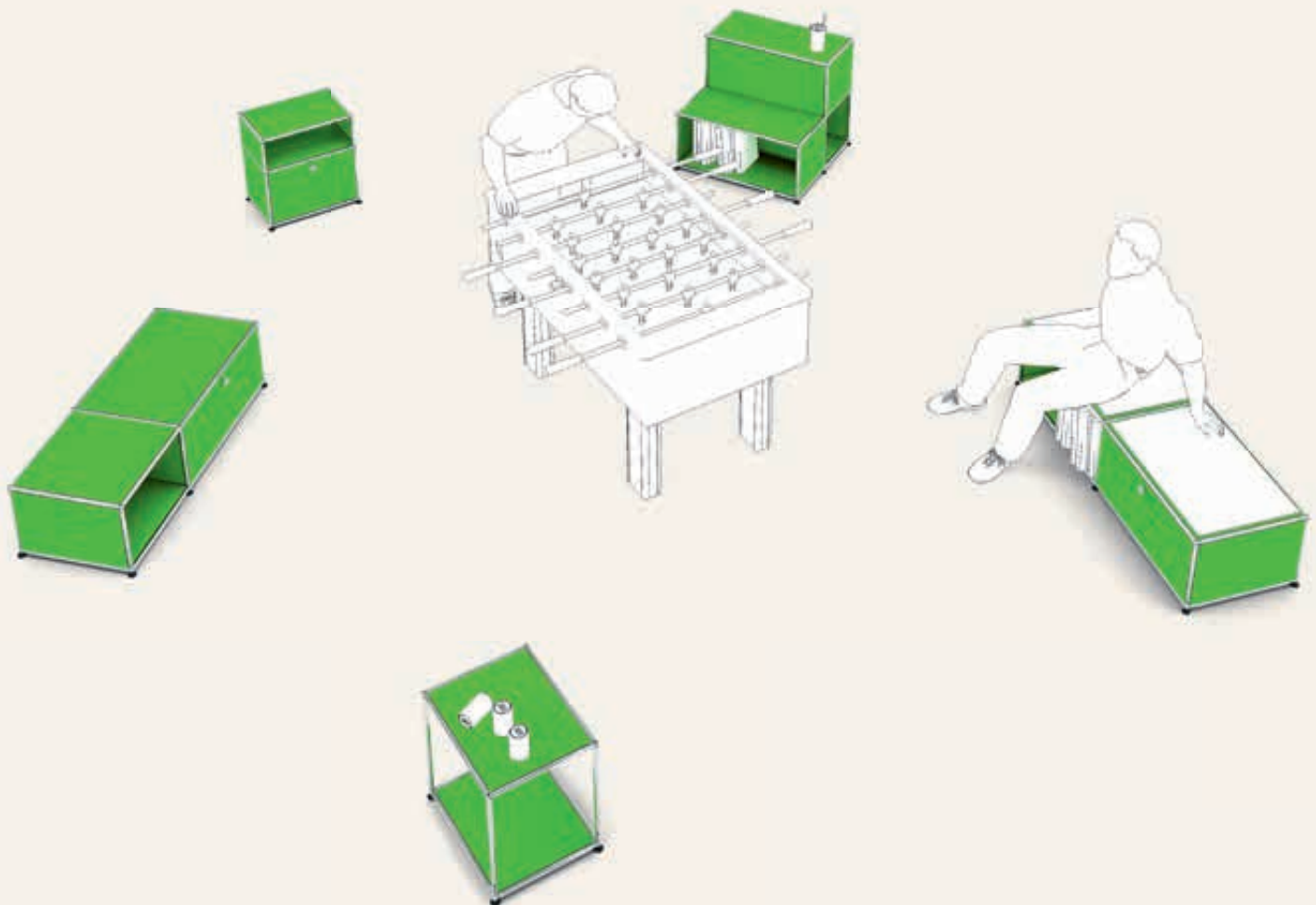
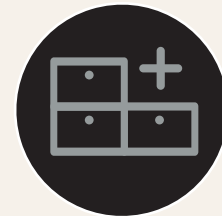

Focus

Creative zone







Thinking space

26.0 A place to retreat in the open-plan office: blue USM Privacy Panels protect you from the outside world and absorb background noise. The pure white USM Haller storage unit is also equipped with acoustic elements – creating the ideal conditions for focused work and creative meetings.



Sound absorption
Perforated metal panels with a fleece-covered interior: acoustic USM Haller elements significantly reduce background noise, improving the overall work environment.

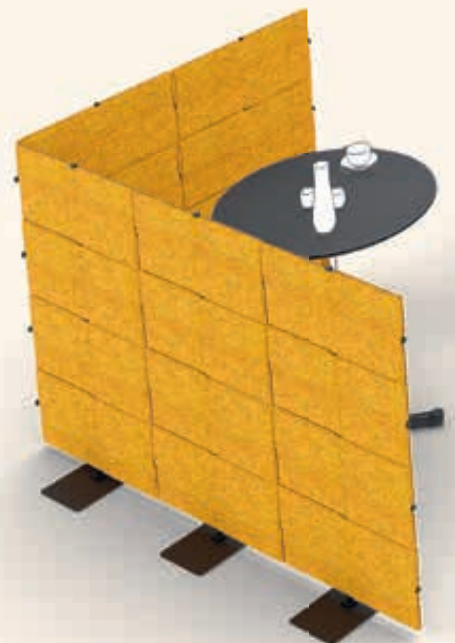

Free structures

The single USM Privacy Panels are also linked to one another by a specific detail in their geometry allowing them to behave as one single surface.

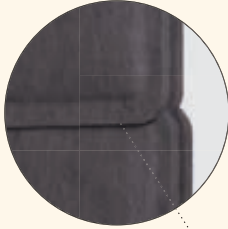

Creative village

27.0 The ways of creating, combining and using focus workstations are countless. USM Privacy Panels offer a modular and flexible way to create breakout areas within a room to enable different work modes in a small space. Add a touch of color where appropriate.



Each area can be customized by size, height, shape and color to serve specific functions and needs. Within a village of workstations, you can tastefully embed meeting zones, relaxation areas, technical zones and storage areas. Plus, everything can be reconfigured at any time!

Focus

Creative space





Focus



Thinking space

28.0 Create a focus zone with yellow USM Privacy Panels. Take a pastel gray laminate USM Haller desk, add a graphite black mobile caddy, and you get the perfect individual workspace – a place to retreat artfully separated from the neighboring workstation.

Secluded space

29.0 USM Privacy Panels help create compact, protected workspaces – varying in size, shape and color, quickly set up and rearranged. We suggest pearl gray laminated USM Haller Advanced desks and ruby red mobile caddies.

Added value
Slide open the USM Haller Advanced table surface to conceal your cables and network access equipment.

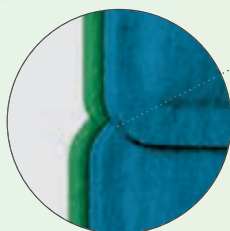

Bicolor
USM Privacy Panels now offer you more freedom of choice: thanks to the modular production process, the front side of each panel can now be given a different color than the back.

Focus

Multiple workstations





Focus

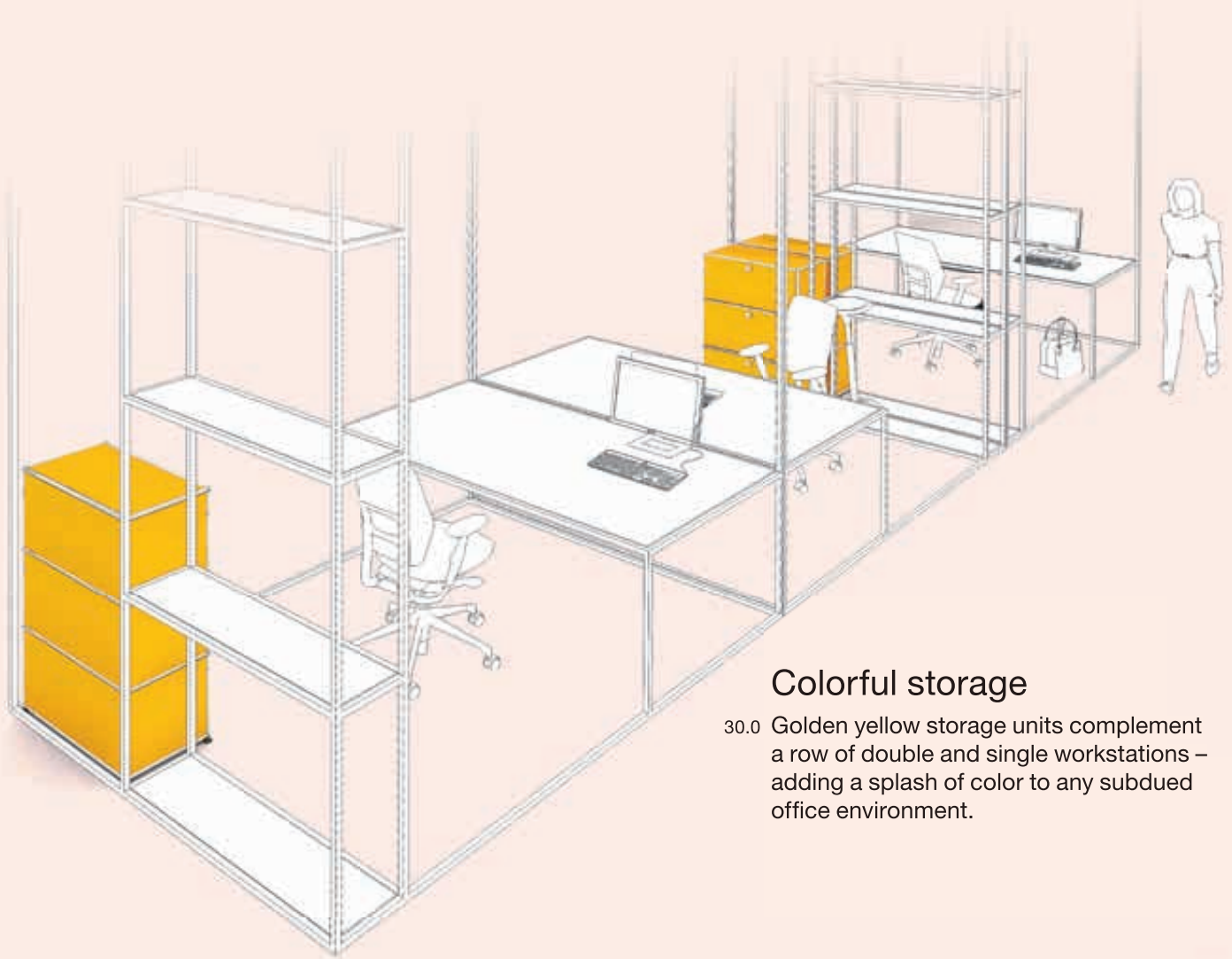

Colorful storage

30.0 Golden yellow storage units complement a row of double and single workstations – adding a splash of color to any subdued office environment.



Easy organization
USM Inos box sets
with five or ten drawers
facilitate your organiza-
tion and help you keep
papers in order.
Discover the full range
of functional accesso-
ries on page 67.

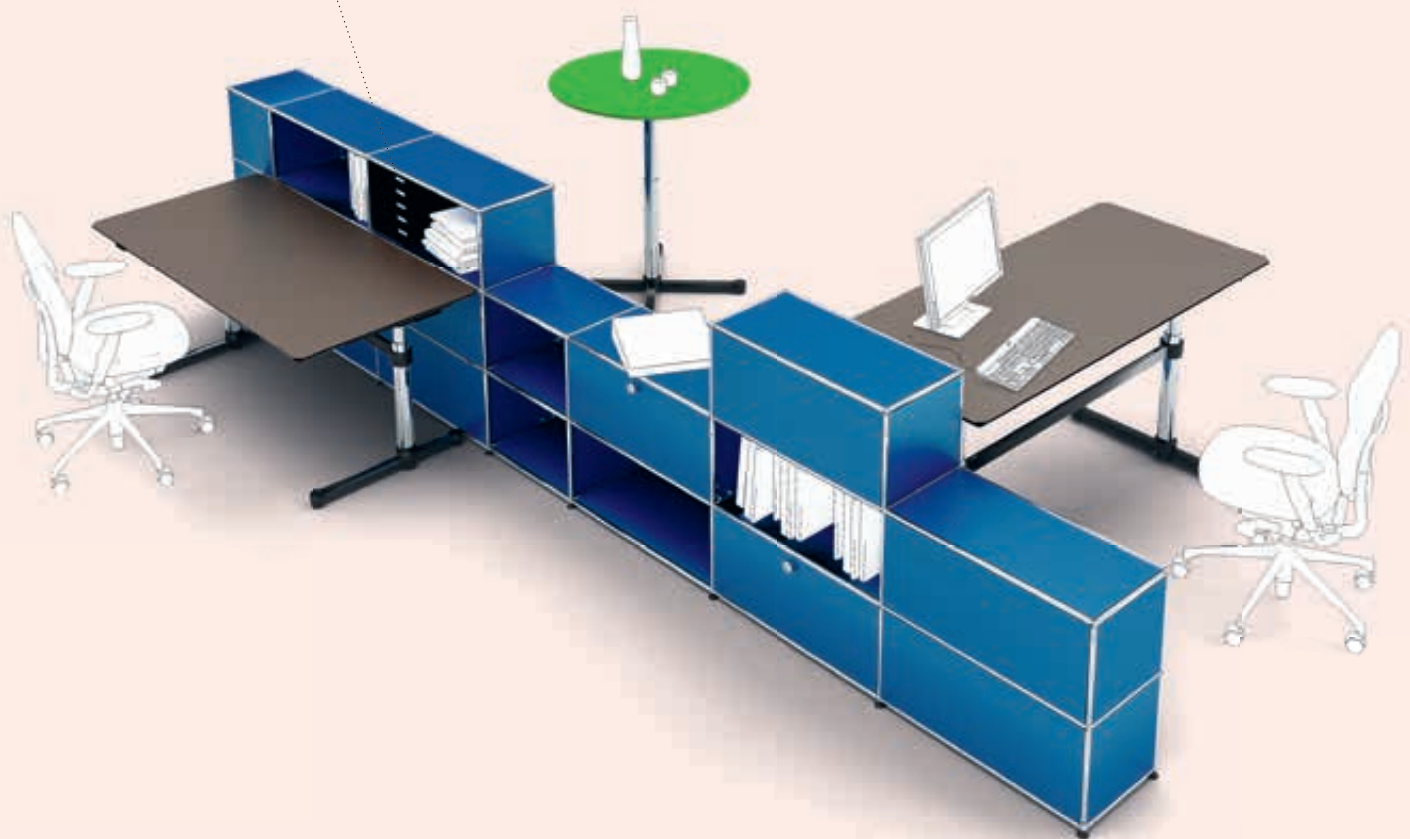

Functional alignment

31.0 Your timeless office layout with style and class and a pleasant dash of color, thanks to the ruby red USM Haller storage units. Dividing the room in a practical way, they are accessible from both sides, optimizing space and function.

Strong connection

32.0 The gentian blue USM Haller storage and organizational unit is the connecting element between two single workstations with electric height-adjustable USM Kitos E tables. The clever bit about it: the unit is accessible from both sides, serving both employees perfectly.

Focus

Individual workstations





Focus



Classic beauty

33.0 A classic double workstation of timeless elegance: black oak veneer USM Kitos M Plus desks with graphite black storage units also serve as room dividers. Simple perfection in timeless beauty.

Team players

34.0 USM Kitos desks in ash linoleum combined with gray Privacy Panels make a modern, flexible office for four colleagues – working individually and in a group whenever necessary. The yellow USM Privacy Panels build a printing station accessible to all team members.



Additional platform
Not only do drop-down
doors beautifully hide
the items behind
them, they also provide
easy access – most
importantly, you can
use them as a work sur-
face that holds up to
10 kilos.

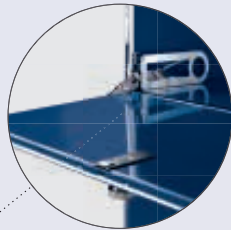

Breathing space

35.0 A double workstation for a well-attuned duo equipped with all the necessary high-quality furniture: USM Privacy Panels in anthracite serve as room dividers, USM Haller tables with steel-blue back-lacquered glass provide extra-spacious work surfaces and steel-blue shelving offers storage.

Focus





Focus



Versatility

The two adaptation points in the tabletop permit easy insertion of up to four accessories, thus making it possible to transform the table to meet individual user requirements.

Shared storage

36.0 We call it a z-configuration. It connects two individual workstations to a single unit: two white oiled-oak veneer USM Haller Plus desks with adaptation points and a shared USM Haller storage with drawers accessible from both sides.

Maximum efficiency

37.0 Four colleagues, little room, full concentration: four pearl gray laminate USM Haller desks, divided by two USM Privacy Panels. Four mid-gray USM Haller storage units with extension doors allow access to the full storage volume.



Space-saving

38.0 Perfection in efficiency: an extremely compact workspace combines USM Kitos M Plus desks in pebble linoleum and small mobile storage units with extra-deep drawers. Three beige storage units complete the setup.



Clean desk
No unsightly cables:
the USM Kitos M Plus
desk is kept clear at all
times. All cables and
network access are under
the tabletop – tidy
and easily accessible.

Focus

Executive offices





Focus



Keep it simple

39.0 This is what your timelessly elegant manager's office could look like: steel-blue back-lacquered etched-glass USM Haller table with a white pedestal – design icons conveying true leadership.

Be iconic

40.0 Authoritative, minimal, sophisticated: the black linoleum USM Haller table and the sideboard with glass showcases your most treasured objects.



Take a seat

- 41.0 This is a manager's office that makes you feel welcome. The USM Haller desk is accompanied by a USM Haller square occasional table, both in anthracite powder-coated MDF. The pure white sideboard blends naturally with its surroundings, while the red return unit makes its presence known.



Sit to stand

- 42.0 The golden yellow shelf marks a colorful accent in this functional yet stylish office. The USM Kitos E Plus desk and USM Kitos E freestanding table, both in charcoal linoleum, are height-adjustable. Sit or stand while working or having a spontaneous meeting.

Focus

Ergonomic offices





Focus



Comfort zone

43.0 Relax and work in a comfortable office: the natural oiled oak veneer USM Kitos E meeting desk provides a generous work surface. The steel-blue powder-coated MDF coffee table invites you to read or relax.



Height adjustment
Simply turn the handle
and the USM Haller
desks adjust to you –
from 680 to 860 mm in
height.



Personalization

44.0 Adjust your desk to a comfortable height: the USM Haller desk in pebble linoleum is equipped with continuous height adjustment from 680 to 860 mm. Slim anthracite shelving provides maximum flexibility; drawers, doors and smart accessories can be added at any time.



Sit to stand

45.0 Meet and chat in an informal, spontaneous way while having a cup of coffee, standing around a natural lacquered beech veneer USM Kitos M meeting desk, which is height-adjustable with zero energy consumption. The elegant pure white USM Haller storage units fit perfectly into the space.

Strong core

values

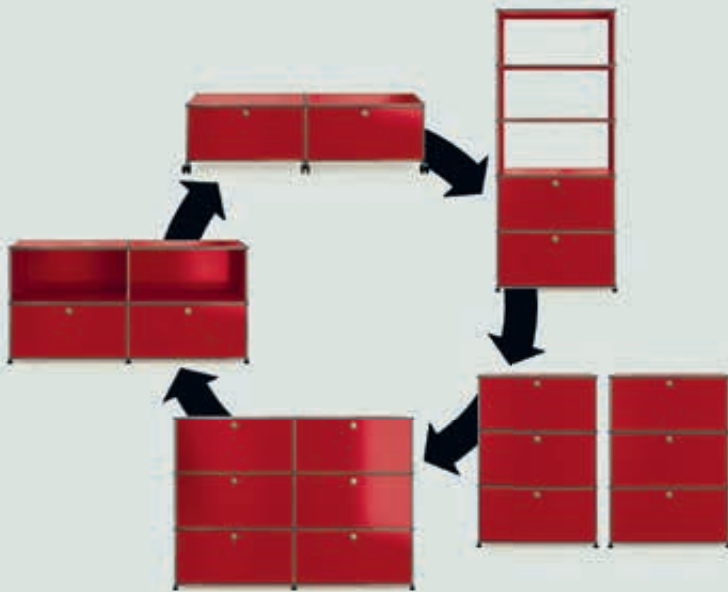

Form follows you

Unlike many static design classics, celebrating individuality by adapting design and function to its user. For more than 50 years, flexibility, durability and consequently sustainability are core values of the USM brand. USM Modular Furniture is designed to be reconfigured – at any time.

Sustainable concepts and actions

Developing solutions that respond to changing needs while remaining environmentally conscious has always been a USM philosophy. Since the beginning, and throughout USM's development, handling energy, emissions, materials and production methods in a responsible manner has been a key mission. In this regard, the longevity of USM products is of utmost importance. The longer the product can be used, the less impact it has on the environment. High-quality, durable materials, manufactured with the latest environmentally friendly technologies, guarantees a long, useful life for our product.



Made in Switzerland

Founded in 1885, USM is a family business now in its fourth generation. «Made in Switzerland» to us is both a promise and an obligation. It stands for precision, quality, dependability, first-rate materials, careful workmanship and total commitment – on behalf of customer interest and out of respect for the environment.



Founded in 1885 and headquartered in Münsingen, Switzerland, USM today is still a family-owned and family-led business, now in its fourth generation.



Worldwide services

USM provides trained specialists in furniture configuration, delivery and installation to ensure professional customer support. For USM assembly and repair, contact us directly or one of our 400 authorised sales partners in 40 countries, guaranteeing top-quality service around the world. Our modular system embodies dependability, and our customer service guarantees that you will receive quick, personalised answers to your questions. For customized advice, do not hesitate to visit our showrooms. USM has established a prominent reputation and international presence with flagship stores in Bern, Berlin, Düsseldorf, Hamburg, London, Munich, New York, Paris, Stuttgart and Tokyo that showcase local culture and offer technical support.

USM Haller

The USM Haller system provides a wide variety of elements in standard sizes. Widths, depths and heights are indicated below. All measurements refer to the distance between axes.



Your safety matters to us. Check out the USM safety instructions now. www.usm.com/safety

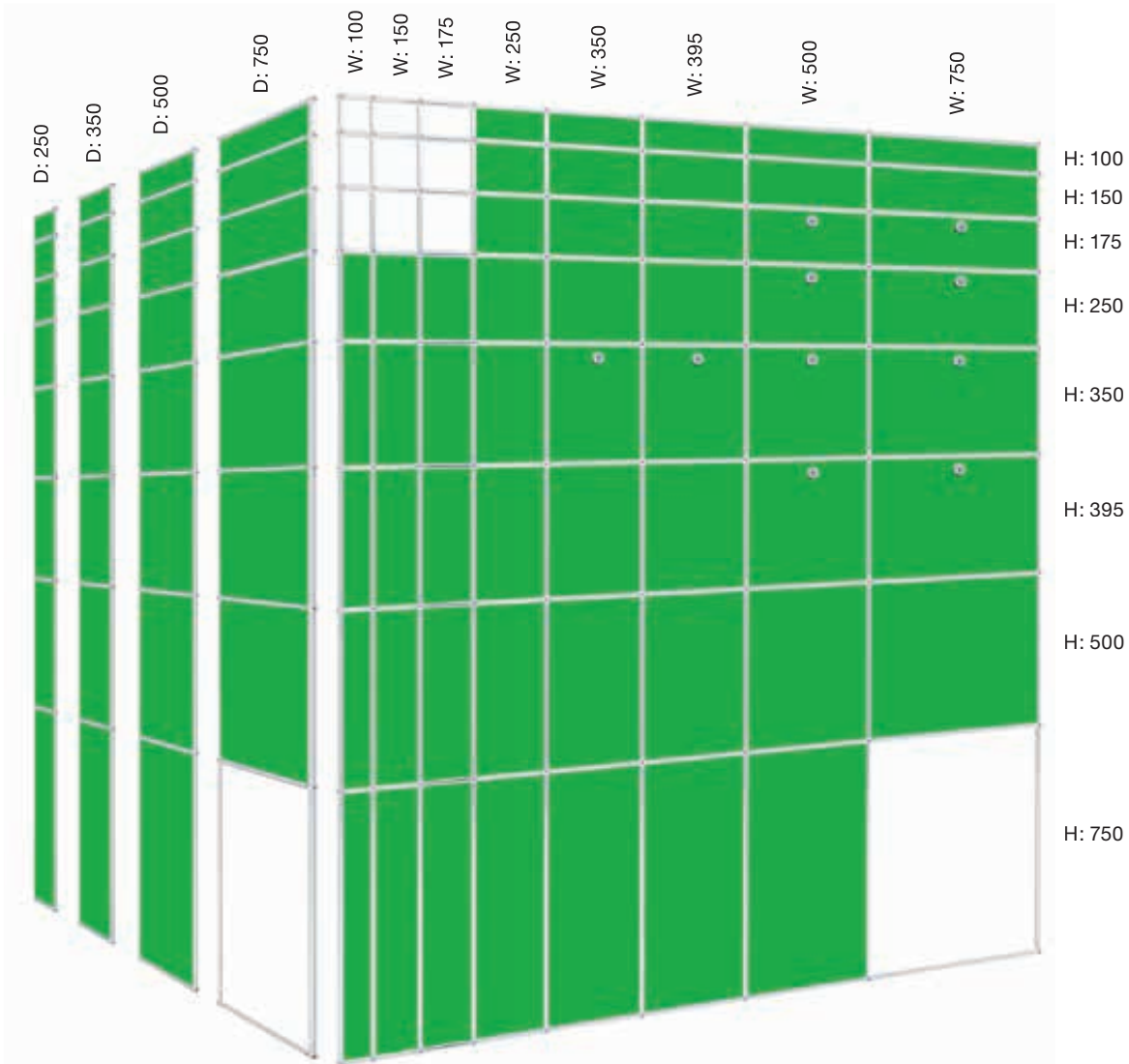
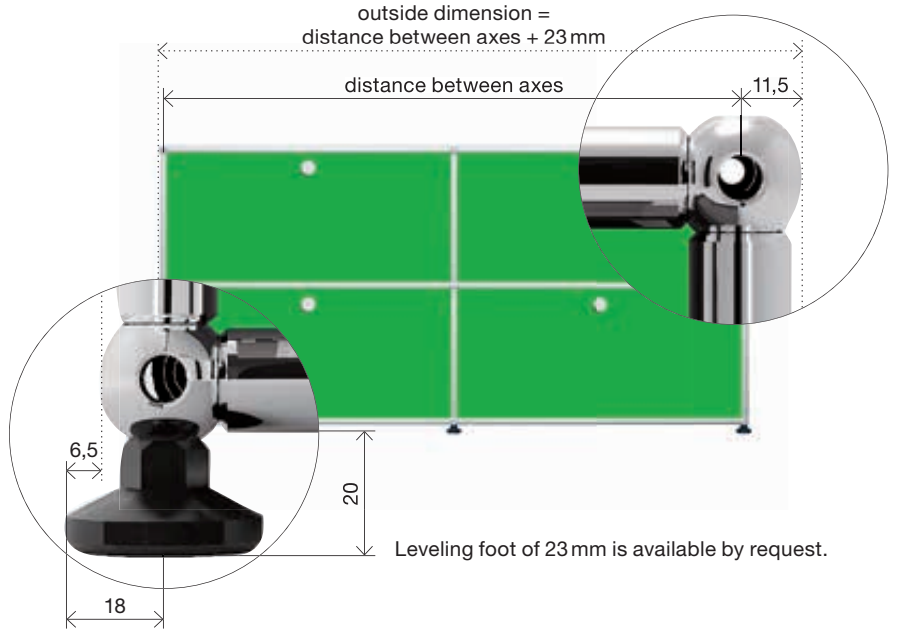

All measurements in mm.

Panels

Doors

Shelves and drawers

Accessories

- 1 Metal panel
- 2 Glass panel
- 3 Acoustic panel
- 4 Perforated metal panel*

- 5 Metal flip-up door*
- 6 Glass door
- 7 Acoustic drop-down door*
- 8 Metal drop-down door
- 9 Metal extension door*

- 10 Metal divider shelf
- 11 Glass divider shelf
- 12 Metal extension shelf
- 13 Metal angled shelf
- 14 Extension filing set with extension shelf
- 15 Small drawer D: 500
- 16 A6 drawer D: 500
- 17 A5 drawer D: 500
- 18 A4 drawer D: 500
- 19 Extension filing set D: 500

- 20 Hanging file baskets
- 21 Metal box insert
- 21a Slide profile for metal box insert
- 22 Cable cut-out
- 23 Metal, magnetic bookend
- 24 USM Inos Box
- 25 USM Inos DVD tray
- 26 USM Inos CD tray

- 27 USM Inos angled file trays
- 28 USM Inos card box set
- 29 Bookend for bookshelf panel (D: 350)
- 30 USM Inos C4 box set, open
- 31 USM Inos C4 box set, closed
- 32 USM Inos drawer organizer set

Start configuring your individual piece of USM now!
www.usm.com



*Acoustic version available.
 USM Inos accessories are available in graphite black and light gray.

Illustration: USM Haller
 in D: 500 mm.
 All measurements in mm.

USM Haller E

Application Options

A modular structure of your design, either completely or partially equipped with e-Balls and e-Tubes, is connected to a source of electricity. The structure itself conducts the low voltage electricity to the desired location using the e-Balls, e-Connectors and e-Tubes to form a circuit. USB chargers or light sources can be snapped into place in pre-cut recesses. The power supply is drawn from any point near the ground. The power supply cable is attached to a Haller e-Ball, and the power adapter is subsequently tucked underneath the furniture until only the operating switch remains visible. From this point the power supply requires no further cables but rather is integrated into the structure of the furniture.

- 1 **Glass Panel**
Glass elements can be illuminated throughout.
- 2 **Without Metal Paneling**
Compartments without metal paneling can be completely illuminated.
- 3 **With Metal Paneling**
Compartments with metal paneling can be illuminated from the front.
- 4 **Compartment with an Extension Shelf**
The entire compartment with an extension shelf can be illuminated.
- 5 **Drop-Down and Extension Door**
Via the "Light When Compartment Is Open" function, the light automatically turns on when the door is opened.
- 6 **Angled Shelf**
The presentation space is illuminated from the front.
- 7 **Floor Lighting**
With floor lighting, the light shines at a 25-degree angle under the furniture.
- 8 **Ambient Lighting**
The light is directed vertically towards the back, illuminating the surroundings with a warm glow.
- 9 **e-USB Charger**
It can be integrated in the same places as the e-Lights.



Winner of the German Design Award 2019 for outstanding design quality in the Office Furniture category



Winner of the Wallpaper Design Awards 2018



Winner of the Focus Gold Award 2018 for outstanding design quality



Winner of the Muuuz International Award 2018 in the furniture category



Winner of the FX Design Awards, Lighting Product 2017



e-Elements

1 e-Lights

Dimmable, available in
– Warm white
2700 Kelvin
– Cold white
5700 Kelvin
Both with or without the “light at compartment opening” function.

2 e-USB Charger

Provides a voltage of 5 volts to the connected device. (Capacity: 6.5 W)

3 e-Dummy

Sleek, black e-Dummy element close recesses that are still unutilised. If a piece of furniture should later be supplemented with additional light, using e-Tubes (consuming), which are first equipped with e-Dummy elements, is recommended.

4 e-Tube (power outlet)

Tubes with recesses for e-Lights, e-USB chargers or e-Dummy elements that can be easily snapped into place or replaced.

L 350, 1 recess
L 500, 2 recesses
L 750, 3 recesses

5 e-Tube (conductive)

The conductive e-Tube serves to conduct the electricity if no inserts are desired in this location. It is available in lengths of 750, 500, 395, 350, 250 and 175 mm.

6 e-Ball, e-Connector

To enable the flow of electricity, the ball and connector were refined. The exterior dimensions remain unchanged. The distinguishing feature of the ball is the black insulation ring.

7 e-Power Supply

Includes dimmer at the operating switch. Transforms the power supply voltage to 24 volts. (Capacity: 60 W)



Engineered & Made in Switzerland.

Only available in certain countries. Please contact USM Switzerland for availability in your country.



USM Haller Table

The USM Haller classic and USM Haller Plus Desk can be equipped with an optional cable basket, while the USM Haller Advanced features integrated smart solutions for electrification. All desks can be equipped with grommet hatches for network access.

Basic table

Optional cable basket underneath the tabletop



USM Haller Classic

H: 740
L: 3000 / D: 1000
L: 3000 / D: 750
L: 2500 / D: 1000
L: 2500 / D: 750
L: 2250 / D: 1000
L: 2250 / D: 750
L: 1000 / D: 1000
L: 750 / D: 750

H: 740 or 680–860*
L: 2000 / D: 1000
L: 2000 / D: 750
L: 1750 / D: 1000
L: 1750 / D: 750
L: 1500 / D: 1000
L: 1500 / D: 750
L: 1250 / D: 750

Sliding tabletop + adaptation points

Integrated cable tray accessible from above by sliding back the tabletop
Adaptation points for accessories



USM Haller Advanced

H: 740 or 680–860*
L: 2000 / D: 1000
L: 2000 / D: 750
L: 1750 / D: 1000
L: 1750 / D: 750
L: 1500 / D: 1000
L: 1500 / D: 750
L: 1250 / D: 750

Working desk

Optional cable basket underneath the tabletop
Removable adaptation points for accessories



USM Haller Plus

H: 740
L: 3000 / D: 1000
L: 3000 / D: 750

H: 740 or 680–860*
L: 2000 / D: 1000
L: 2000 / D: 750
L: 1750 / D: 1000
L: 1750 / D: 750
L: 1500 / D: 1000
L: 1500 / D: 750
L: 1250 / D: 750

Occasional table



USM Haller occasional table, square

H: 370
L: 3000 / D: 1000
L: 3000 / D: 750
L: 2500 / D: 1000
L: 2500 / D: 750
L: 2250 / D: 1000
L: 2250 / D: 750
L: 2000 / D: 1000
L: 2000 / D: 750
L: 1750 / D: 1000
L: 1750 / D: 750
L: 1500 / D: 1000
L: 1500 / D: 750
L: 1250 / D: 750
L: 1000 / D: 1000
L: 750 / D: 750

*Manual height adjustment with a removable handle.
All measurements in mm.

Accessories
for all USM Haller Desks

- 1 **Grommet hatch for network access**
Flush hinged cover set into the tabletop for easy network access, can be positioned at two different locations.
- 2 **Cable management**
For the Advanced table type, a cable tray integrated under the tabletop offers storage room and attachment options for all cables and technical components. For the traditional USM Haller Table and the USM Haller Plus, a cable basket can be attached.
- 3 **CPU holder**
Computers in various sizes can be mounted using a simple holding device under the table.
- 4 **Link chain**
Holds and directs cables to the power source. Flexible and adjustable to various lengths.
- 5 **Power strip**
Can be configured individually for data and power supply according to country-specific requirements. Available with a 4 m cable. Magnetically fixed in the cable tray.
- 6 **Flat screen pivot arm**
Screens are screwed to the height adjustable pivot arm using a mounting plate (VESA standard). Available for USM Haller classic desk: The pivot arm can be mounted onto the table edges with the universal holder or into the table leg using an assembly tube. Available for USM Haller Plus and Advanced: The bracket can be connected directly to one of the adaptation points.
- Options
6a **Mounting at different heights**
is possible for screens weighing up to 12 kg.
6b **Continuous height adjustment**
for screens weighing up to 12 kg.

Cable duct

The classic USM Haller table can be updated with a black aluminum cable duct section, with lids that fold open on both sides, to integrate power strips (5) and cables. This enables the table depths to be expanded to the EU standard of more than 800 mm. For table heights of 2000, 1750, 1500, 1250, 1000, 900, 750.

Accessories
for USM Haller Desk Plus/ Advanced

- 7 **Front and side panel**
A black mesh fabric can be attached to the back or the side under the table frame. Available for the following table lengths: 2000, 1750, 1500, 1250, 1000, 750 and depths: 1000, 750.
- 8 **Material tray**
Provides room for writing instruments and can be discreetly stowed under the tabletop.
- 9 **USM Privacy Panels**
Can be attached to the long side to ensure individuality and privacy for people working at tables configured as a block station. H: 350 or 700. Available for the following table lengths: 3000, 2500, 2250, 2000, 1750, 1500, 1250*
*only for Haller tables without Adaptation points
- 10 **Flat screen support bar**
The bracket is inserted into the adaptation points. Up to two screens (max. 2 x 12 kg) can be attached using a mounting plate (VESA standard). Screens can be mounted at different heights; screens can be adjusted with ball joints.
- Options
10a **Flat screen support bar fix**
10b **Flat screen support bar adjustable**
Move forwards or backwards 2 notches at a time to adjust the viewing distance.
- 11 **USB adapter**
The adapter is suitable for USB 2.0 and 3.0 ports; it can easily be inserted into the adaptation point. Usable as power supply or for data transfer.
- 12 **Lamp peg**
An optional lamp peg for easy attachment of traditional table lamps. Electrification is possible through the adaptation point.

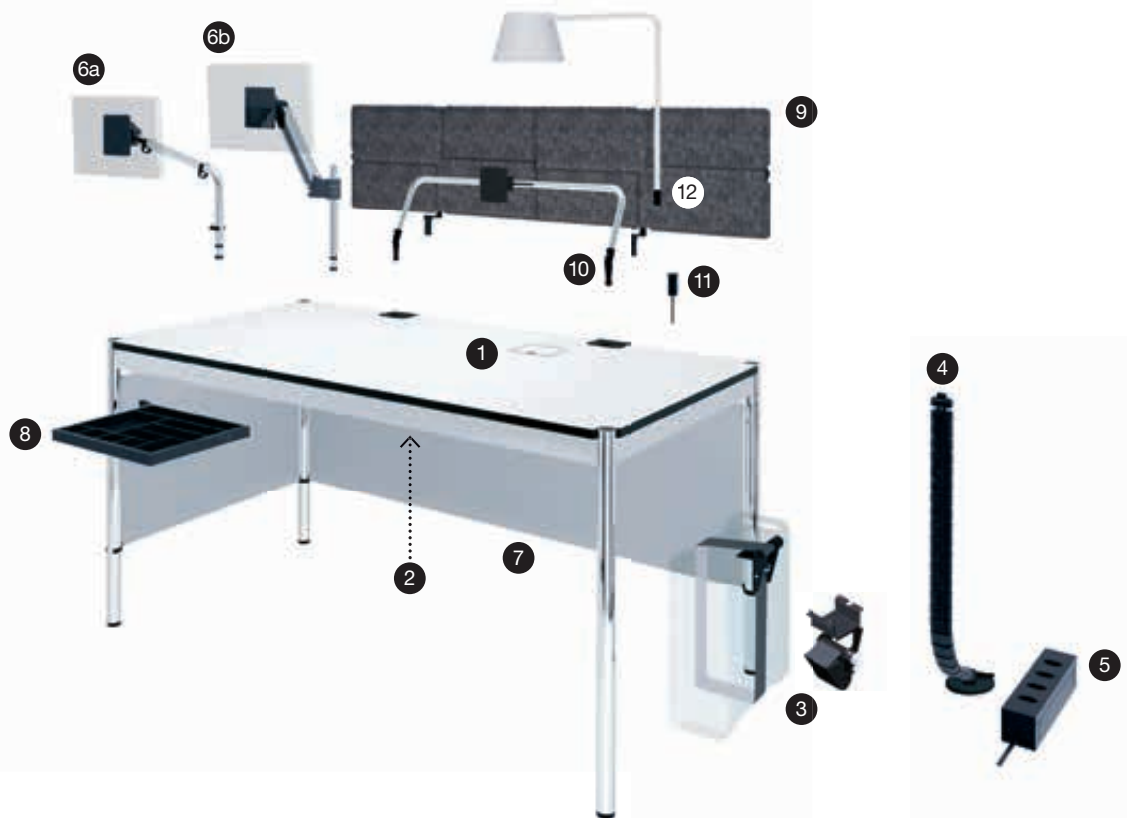

USM Kitos M and E Desk

Each desk (except free-standing) of the USM Kitos M and E family offers integrated smart solutions for electrification.

Why USM Kitos M?

The "M" in its name stands for mechanical spring-loaded height adjustment; adjustment time approx. 1 sec. with zero energy consumption. This system is more than 10 times faster than the electronic equivalent and has an extremely long operating life.

Why USM Kitos E?

Maximum functionality and captivating design – USM Kitos E unites all requirements in one modern workplace: continuous height adjustability and maximum stability. A distinction is made between fixed and motor-driven legs in the E1, E2 and E3 models.

E1



H: 740
With or without middle traverse

E2 with 1 motor



H: 700–1200
Adjustment time approx. 30 sec.
With middle traverse

E3 with 2 motors



H: 650–1300
Adjustment time approx. 20 sec.
With middle traverse

Basic desk

Integrated cable tray underneath the tabletop



USM Kitos M

H: 700–1200
L: 1800 / D: 900
L: 1750 / D: 750
L: 1600 / D: 800

USM Kitos E

L: 1800 / D: 900
L: 1750 / D: 750
L: 1600 / D: 800
Available with E1*, E2 or E3** columns

Sliding tabletop

Integrated cable tray accessible from above by sliding back the tabletop

Adaptation points for accessories



USM Kitos M Plus

H: 700–1200
L: 1800 / D: 900
L: 1750 / D: 750
L: 1600 / D: 800

USM Kitos E Plus

L: 1800 / D: 900
L: 1750 / D: 750
L: 1600 / D: 800
Available with E1*, E2 or E3 columns

Extra size

Integrated cable tray underneath the tabletop and accessible from all sides



USM Kitos M Meeting

H: 700–1150
L: 2500 / D: 1000
L: 2250 / D: 1000

USM Kitos E Meeting

L: 2500 / D: 1250
L: 2500 / D: 1000
L: 2250 / D: 1000
Available with E1, E2 or E3 columns

Side table



USM Kitos E Free-standing

H: 740 or 700 – 1110
Square
L: 750 and 900
Round
Ø: 900 and 1100

* Available with or without middle traverse.

**Available in a GS-Mark tested version with 3 mm table edge radius and the asymmetrical middle traverse.

The table can also be provided with an asymmetrical version of the middle traverse, for extra legroom. (This is not possible with the USM Kitos E / M Meeting.)

All measurements in mm.

Accessories

for all USM Kitos M and E Desks

- 1 **Grommet hatch for network access**
Flush hinged cover set into the tabletop for easy network access, can be positioned at two different locations.
- 2 **CPU holder**
Computers in various sizes can either be mounted using a simple holding device under the height-adjustable tabletop or attached to the table column.
- 3 **Link chain**
Holds and directs cables to the power source. Flexible and adjustable to various lengths.
- 4 **Power strip**
Can be configured individually for data and power supply according to country-specific requirements. Available with a 4 m cable. Magnetically fixed in the cable tray.
- 5 **USM Privacy Panels**
Can be attached to the long side to ensure individuality and privacy for people working at tables configured as a block station. H: 350 or 700. Available for the following table sizes: 2500, 2250, 1800, 1750, 1600.

Accessories

for all USM Kitos M and E Desks, except USM Kitos M Meeting/ E Meeting

- 6 **Flat screen pivot arm**
Screens are screwed to the height adjustable pivot arm using a mounting plate (VESA standard). Available for USM Kitos E/M desk: The pivot arm can be mounted onto the table edges with the universal holder. Available for USM Kitos M and E Plus: The bracket can be connected directly to one of the adaptation points.
- 6a **Mounting at different heights**
is possible for screens weighing up to 12 kg.
- 6b **Continuous height adjustment**
for screens weighing up to 12 kg.
- 7 **Front panel**
A black mesh fabric attaches to the front under the tabletop. Available for the following table sizes: 1800, 1750, 1600.
- 8 **Material tray**
Provides room for writing instruments and can be discreetly stowed under the table

Accessories

for USM Kitos M Plus / E Plus

- 9 **Flat screen support bar**
The bracket is inserted into the adaptation points. Up to two screens (max. 2 x 12 kg) can be attached using a mounting plate (VESA standard). Screens can be mounted at different heights; screens can be adjusted with ball joints.
- 9a **Flat screen support bar fix**
- 9b **Flat screen support bar adjustable**
Move forwards or backwards 2 notches at a time to adjust the viewing distance.
- 10 **USB adapter**
The adapter is suitable for USB 2.0 and 3.0 ports. It can be inserted easily into the adaptation point. Usable as power supply or for data transfer.
- 11 **Lamp peg**
An optional lamp peg for easy attachment of traditional table lamps. Electrification is possible through the adaptation point.

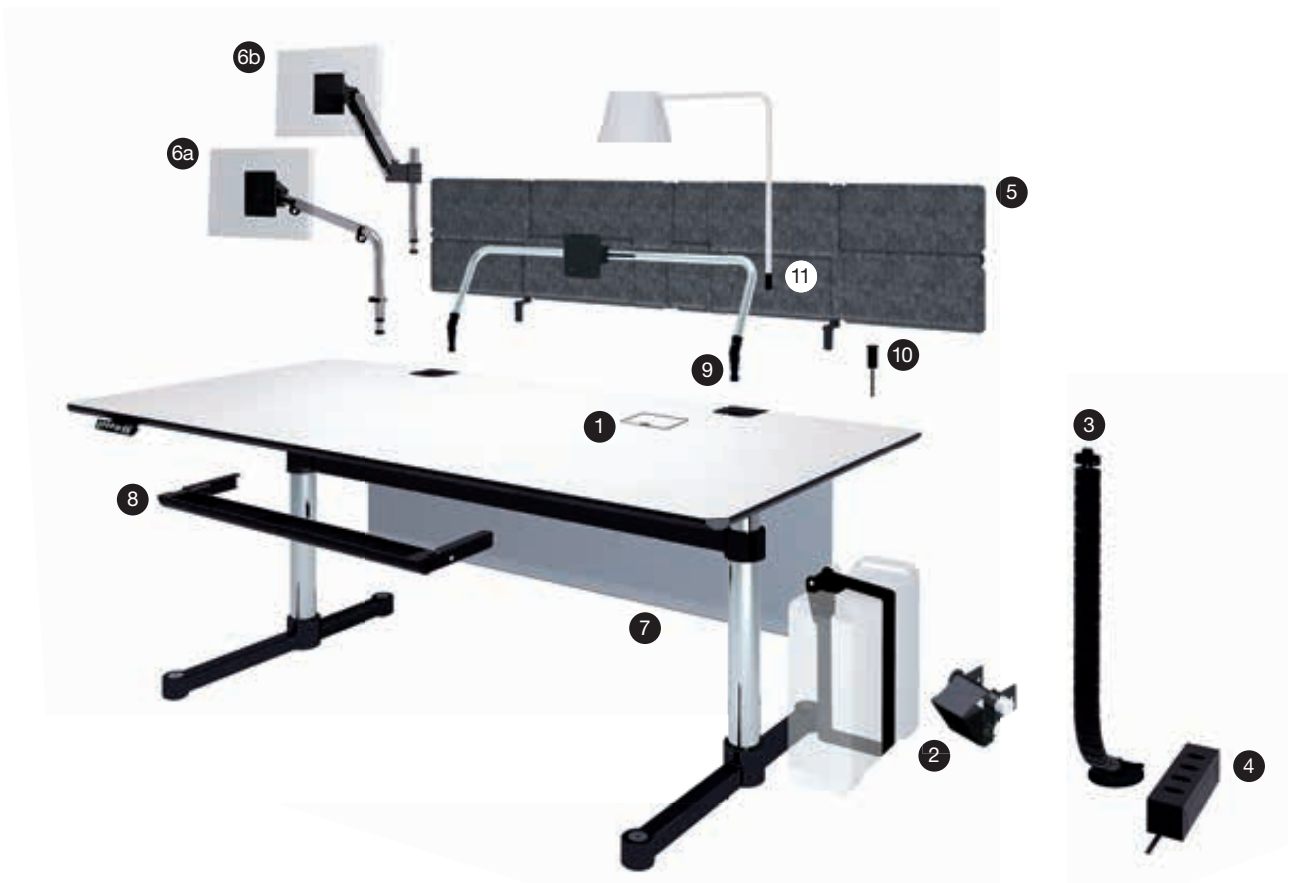

USM Kitos Desk

Available at a fixed height, with stepwise or free-flow height adjustment, which can be adjusted electronically.

Rectangular



USM Kitos Rectangular

H: 740
L: 1800 / D: 900
L: 1750 / D: 750
L: 1500 / D: 750
L: 900 / D: 750

Stepwise height adjustment
H: 680–780 / 1060
L: 1800 / D: 900
L: 1750 / D: 750
L: 1500 / D: 750
L: 900 / D: 750

Continuous height adjustment
H: 700–1200*
L: 1800 / D: 900
L: 1750 / D: 750
L: 1500 / D: 750
L: 900 / D: 750

Side table



USM Kitos Free-standing

H: 740
Square
L: 900, 750
Round
Ø: 1100, 900

Stepwise height adjustment
H: 680–780 / 1060
Square
L: 750
Round
Ø: 900
Rectangular
L: 900 / D: 750

Continuous height adjustment
H: 680–1090*
Square
L: 750
Round
Ø: 900

*Not available in glass.
All measurements in mm.

Accessories
for all USM Kitos classic desks

- 1 **Universal support**
Mounts to the table support or directly to the tabletop to hold various accessories.
- 2 **Flat screen pivot arm**
Screens are screwed to the height-adjustable pivot arm using a mounting plate (VESA standard). This can be mounted onto the tabletop using the universal support (1).
- 3 **Cable duct**
Black aluminum profile to accommodate power strips (6) and cables. With a hinged cover on both sides.
Available for the following table lengths: 1800, 1750, 1500, 900
- 4 **USM Privacy Panels**
Can be attached to the long side to ensure individuality and privacy for people working at tables configured as a block station. H: 350, 700.
Available for the following table lengths: 1800, 1750, 1500
- 5 **Link chain**
Holds and directs cables to the power source. Flexible and adjustable to various lengths.
- 6 **Power strip**
Can be configured individually for data and power supply according to country-specific requirements. Available with a 4 m cable. Is magnetically attached under or over the table or to a piece of furniture or can be integrated into a cable tray.
- 7 **CPU holder**
Mounts to the table supports. Height-adjustable and rotating. An adjustable strap ensures a secure fit for most standard CPUs.
- 8 **Cable wire basket**
Mounts to the underside of the work surface.
- 9 **Material tray**
Mounts and pivots out from under the table surface.



All measurements in mm.

USM Privacy Panels

USM Privacy Panels are a flexible and extendable modular system made up of individual panel units. Each panel unit consists of two layers of molded polyester fabric with a tubular cross-beam. They can be used in a free-standing version or mounted on tables to divide up the workspace, ensure privacy and absorb unwanted noise.



Winner of the German Design Award 2017



Winner of the Design Preis Schweiz 2015/16



The panels are available in two sizes, a smaller version measuring 250 × 350 mm and a larger version measuring 750 × 350 mm. These dimensions are chosen to match those of USM Haller storage and desks. All measurements refer to the distance between axes.

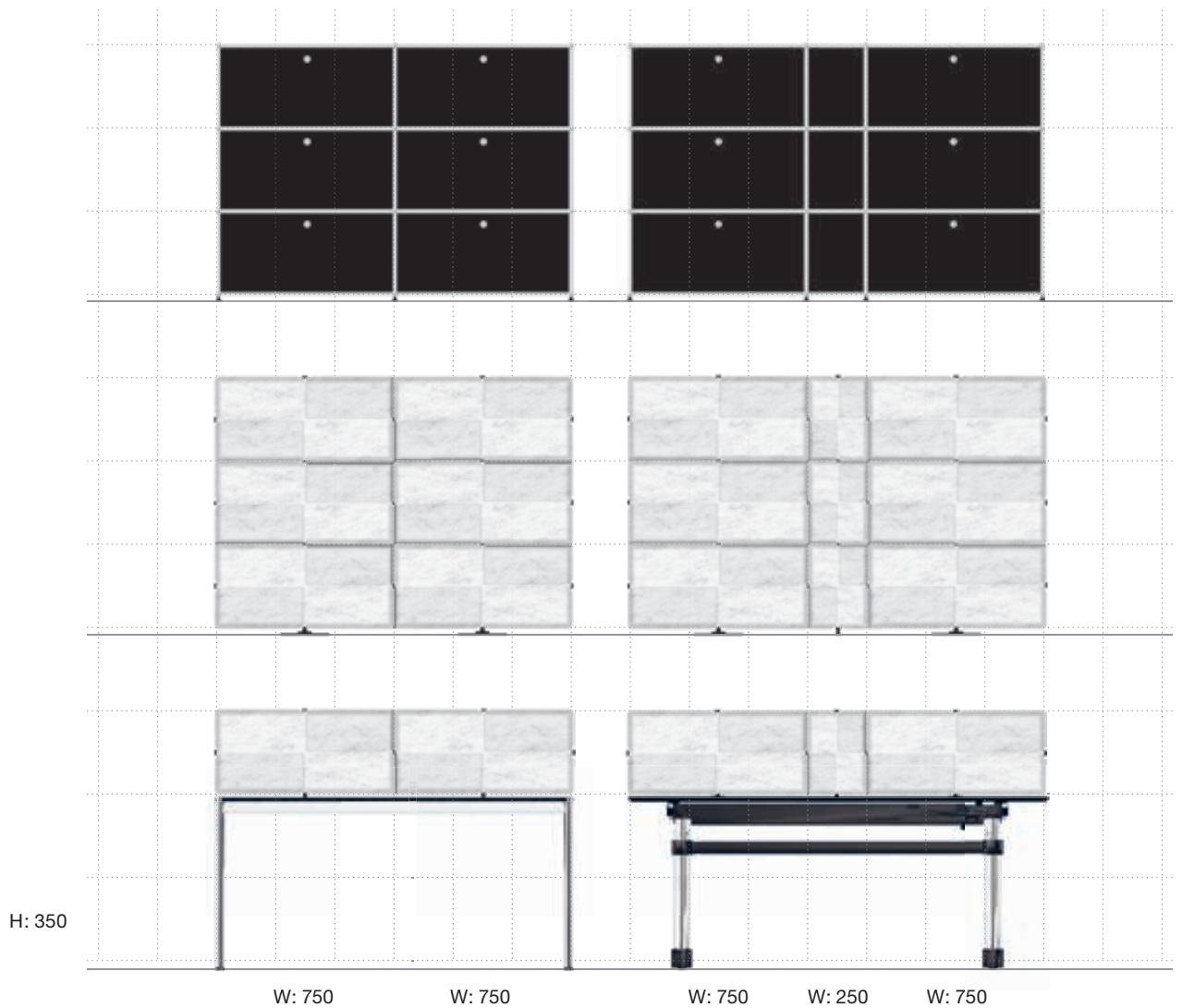
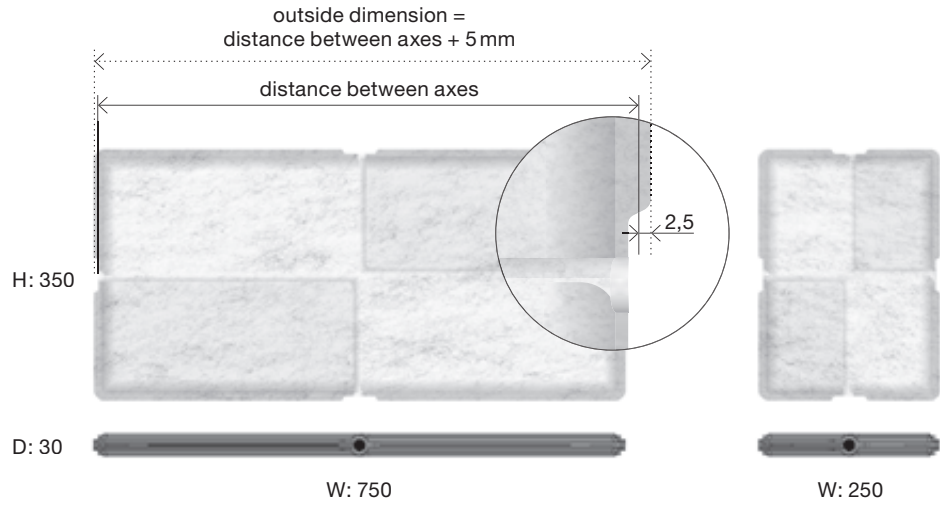

Colors & surfaces

USM Haller



Metal



Pure white
RAL 9010



Light gray
RAL 7035



USM matte silver



Mid-gray
RAL 7005



Anthracite
RAL 7016



Graphite black
RAL 9011



Steel blue
RAL 5011



Gentian blue
RAL 5010



USM green



Golden yellow
RAL 1004



Pure orange
RAL 2004



USM ruby red



USM brown



USM beige

USM Haller and USM Kitos Tables



Powder-coated MDF



Pure white
RAL 9010

Back-lacquered clear glass



Pure white
RAL 9010



Light gray
RAL 7035



USM matte silver



Mid-gray
RAL 7005



Anthracite
RAL 7016



Graphite black
RAL 9011



Steel blue
RAL 5011



Gentian blue
RAL 5010



USM green



Golden yellow
RAL 1004



Pure orange
RAL 2004



USM ruby red



USM brown



USM beige

Back-lacquered etched glass



Pure white
RAL 9010



Light gray
RAL 7035



Mid-gray
RAL 7005



Anthracite
RAL 7016



Graphite black
RAL 9011



Steel blue
RAL 5011

Transparent glass



Transparent glass

Other colors and surfaces available upon request.

Prices and delivery times of table surfaces upon request.

USM Inos accessories are available in graphite black and light gray.

The tabletops in glass are only available for USM Haller Desks up to L: 2000 mm and all USM Kitos Desks with a fixed height (H: 740 mm) or stepwise height adjustment and continuous height adjustment (H: 680–780 / 1060 mm).

USM Privacy Panels



Linoleum



Ash linoleum



Charcoal linoleum

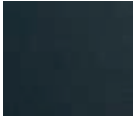

Black linoleum



Pebble linoleum



Mauve linoleum

Laminate

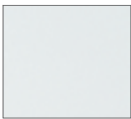

Pearl gray laminate



Pastel gray laminate



Light mid-gray laminate



Dark warm gray laminate

Oiled or lacquered veneer



White oiled oak veneer



Natural oiled oak veneer



Brown oiled oak veneer



Natural lacquered oak veneer



Natural lacquered beech veneer



Black lacquered oak veneer

Fabric panel



Light gray



Anthracite



Blue



Green



Yellow

Switzerland

USM U. Schärer Söhne AG
Thunstrasse 55, 3110 Münsingen
Phone +41 31 720 72 72, info.ch@usm.com

Germany

USM U. Schärer Söhne GmbH
Siemensstraße 4a, 77815 Bühl
Phone +49 7223 80 94 0, info.de@usm.com

France

USM U. Schärer Fils SA, Showroom
23, rue de Bourgogne, 75007 Paris
Phone +33 1 53 59 30 37, info.fr@usm.com

United Kingdom

USM U. Schaerer Sons Ltd., London Showroom
Ground Floor, 49–51 Central St., London, EC1V 8AB
Phone +44 207 183 3470, info.uk@usm.com

USA

USM U. Schaerer Sons Inc., New York Showroom
28–30 Greene Street, New York, NY 10013
Phone +1 212 371 1230, info.us@usm.com

Japan

USM U. Schaerer Sons K.K., Tokyo Showroom
Marunouchi MY PLAZA 1 · 2F
2-1-1 Marunouchi, Chiyoda-ku, Tokyo 100-0005
Phone +81 3 5220 2221, info.jp@usm.com

All other countries
contact USM Switzerland.

www.usm.com