

D'Armes designs, manufactures
& markets unprecedented, high
quality light fixtures.

Catalog 2019



Hartau



Hartau — Simple



Series' Materials

Aluminum, glass & brass

Series' Colors

- Matte black, Ral 9011
- Matte white, Ral 9010
-
- Natural brass (Details)
- Oxidized brass (Details)

Series' Lighting

G9 bulb LED, dimmable
2700k, 350 lumens/bulb

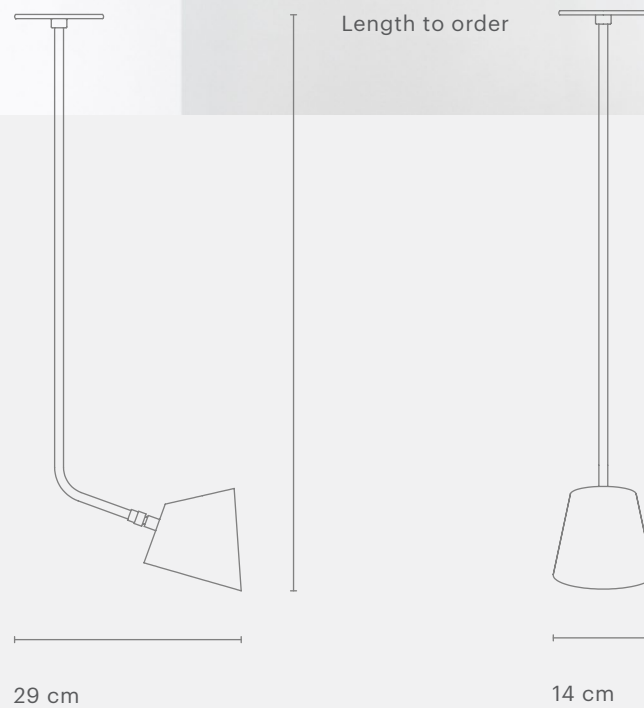



Hartau — Wall

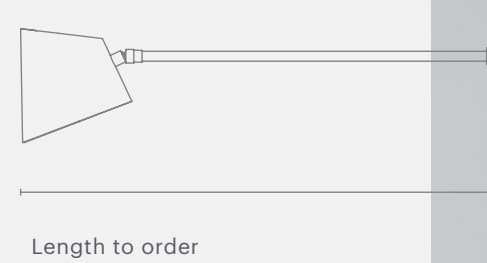
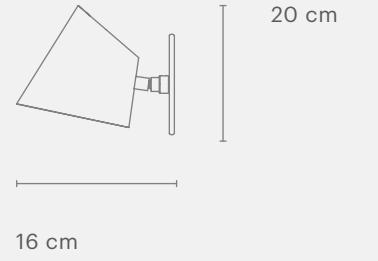



Hartau — Table

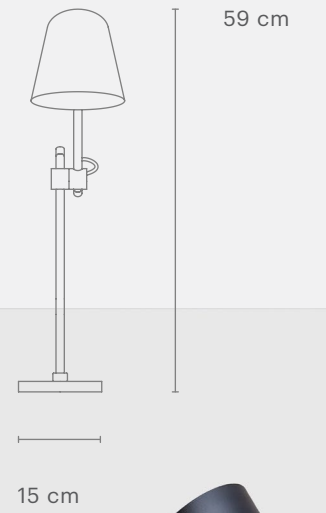

Hartau — Double



14 cm

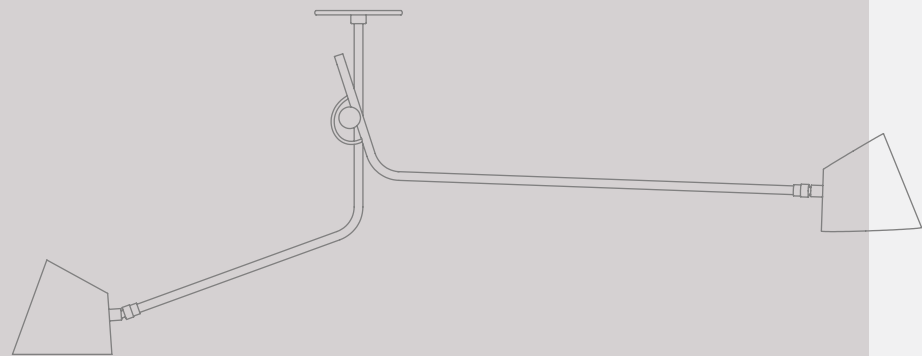
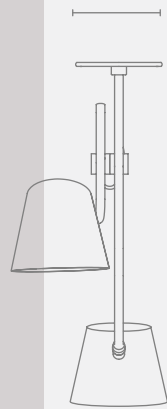

133 cm

Length to order

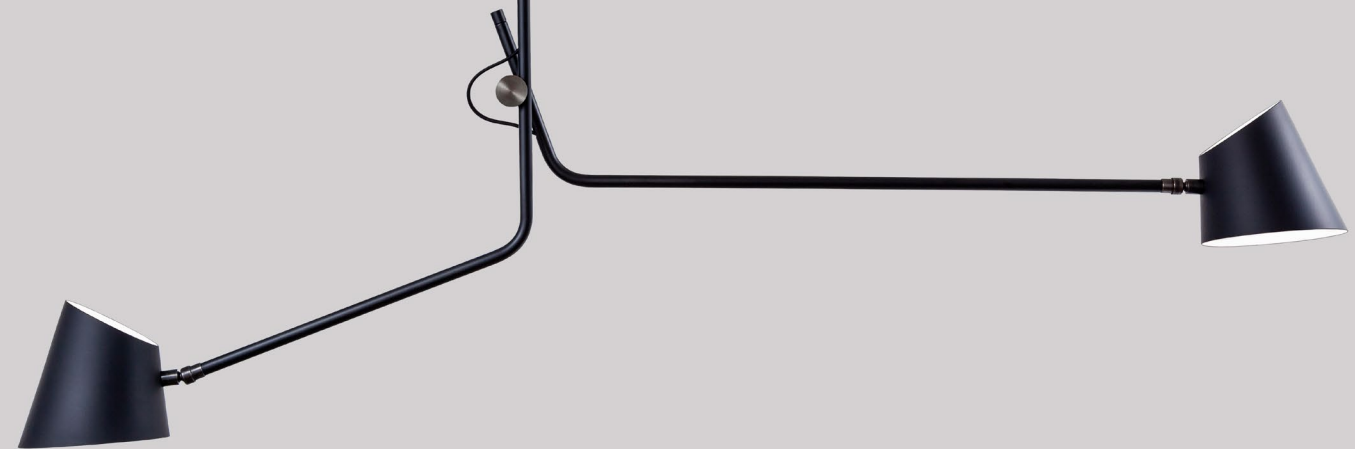

Hartau — Triple

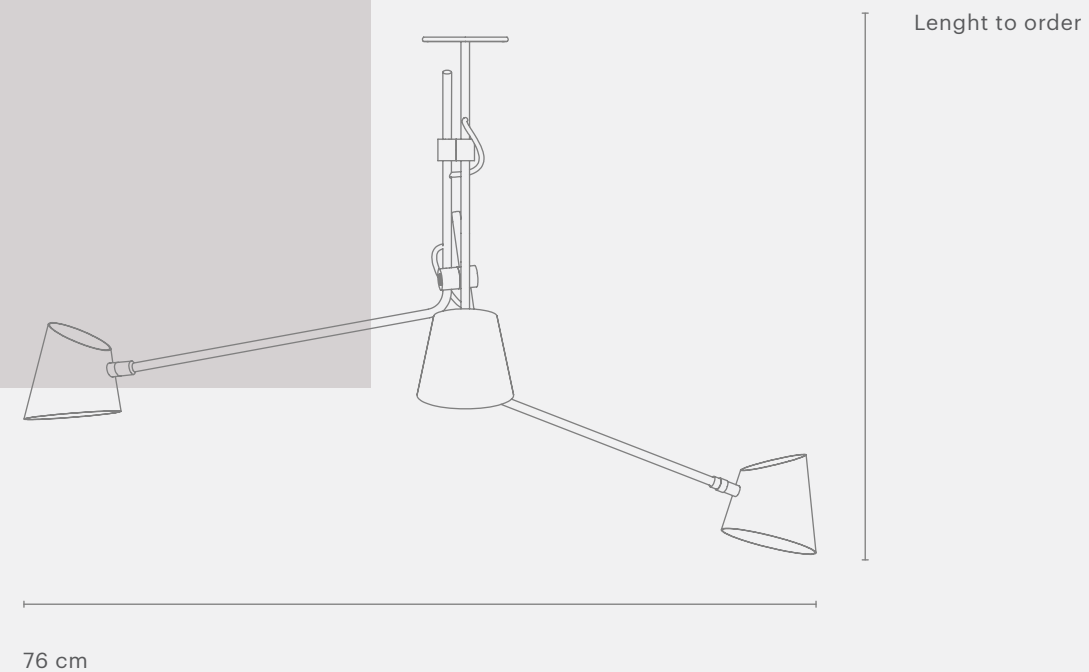

The lampshades are the signature of this collection. With their two openings they offer both direct and indirect light to the wall or the ceiling. They accommodate a frosted glass tube that diffuses the light from a mini LED.

76 cm

Cé

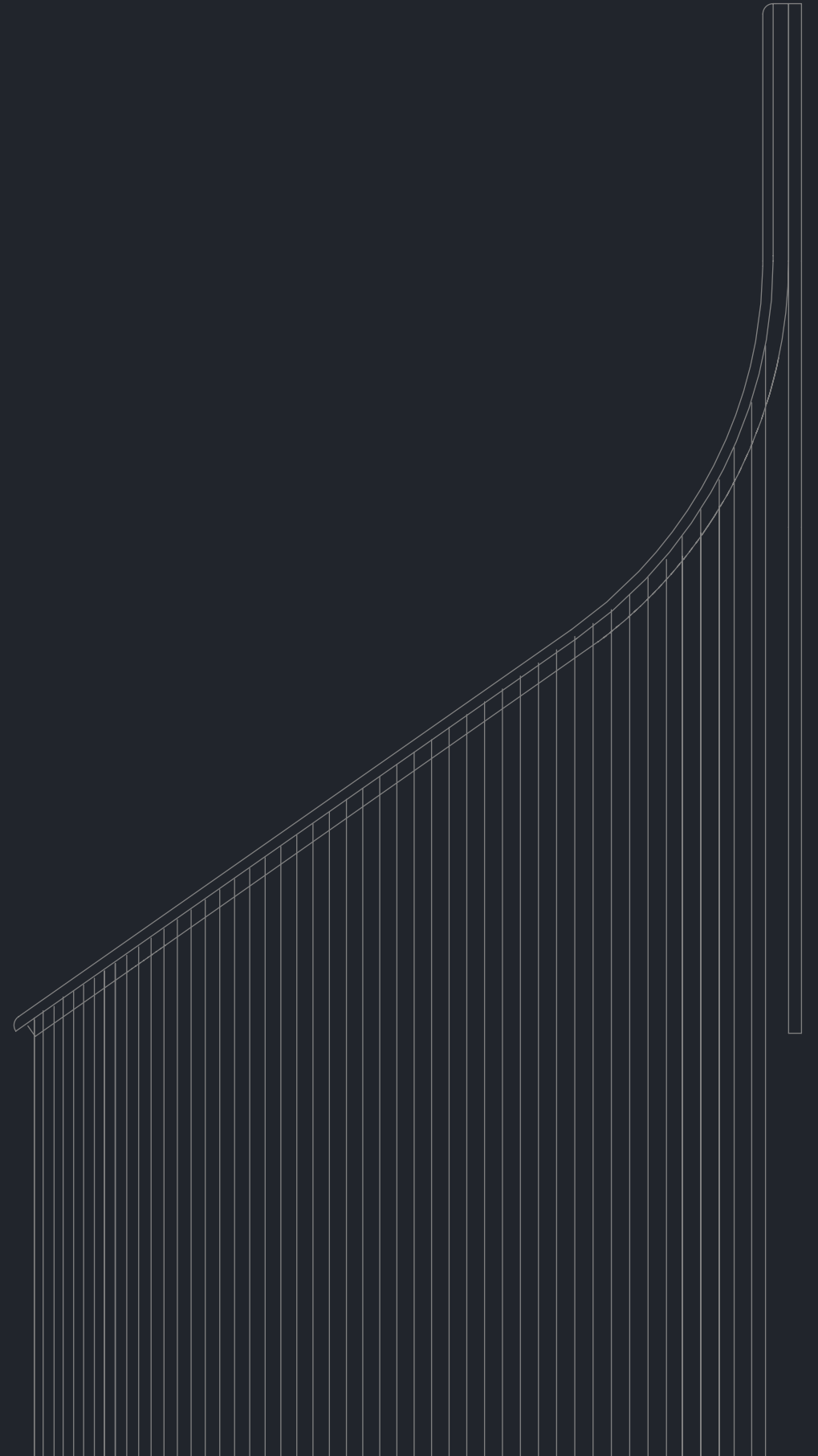

Cé — Wall



25 cm

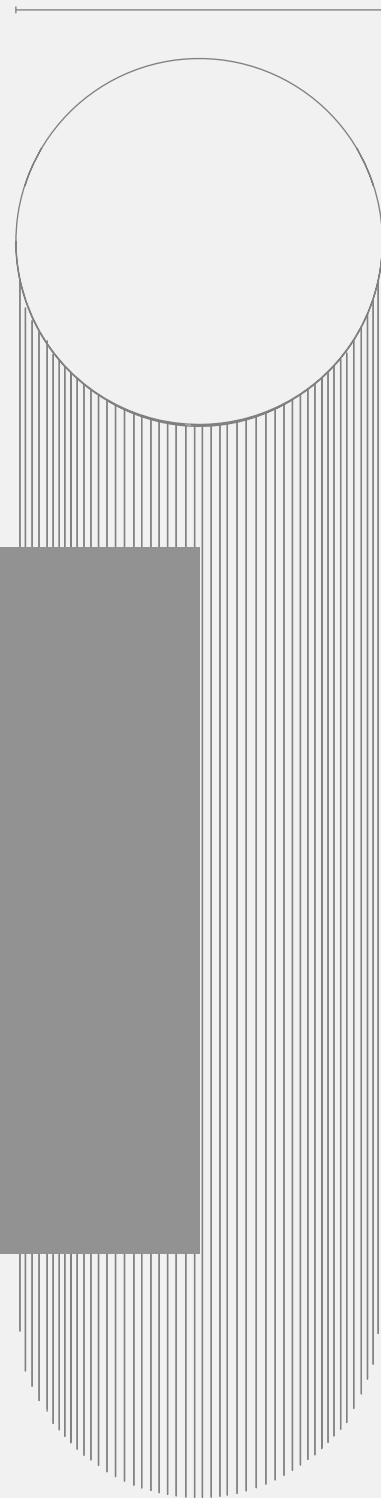

20 cm

100 cm

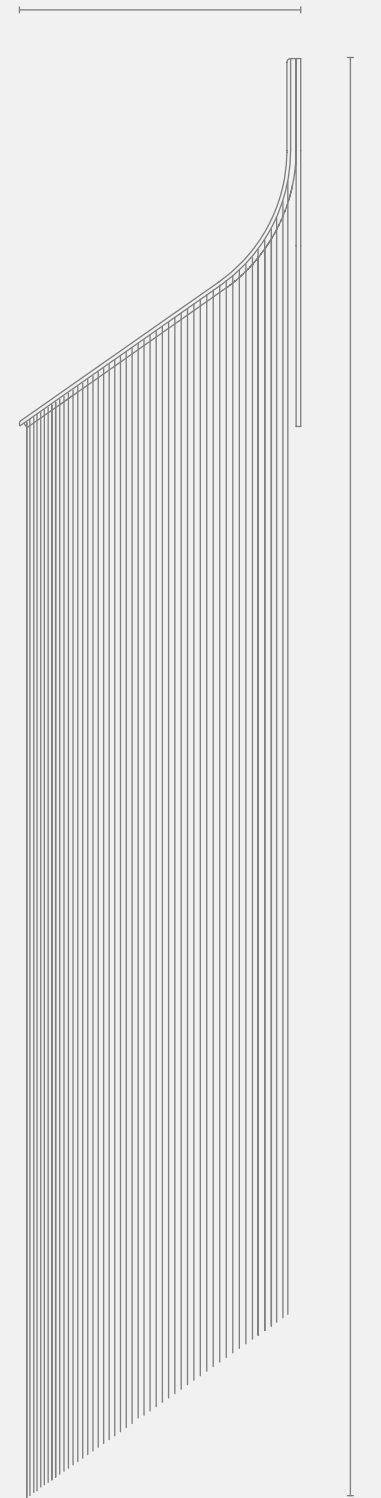

Cé Wall Materials

Solid bronze & rayon fringe

Cé Wall Colors

- Natural bronze
- Oxidized bronze
-
- Verdigris (Fringe)

Cé Wall Lighting

LED, dimmable
3000k, 1600 lumens

**Cé audaciously blends fringes
and solid bronze revealing a well-
rounded wall mounted fixture.**



Ra

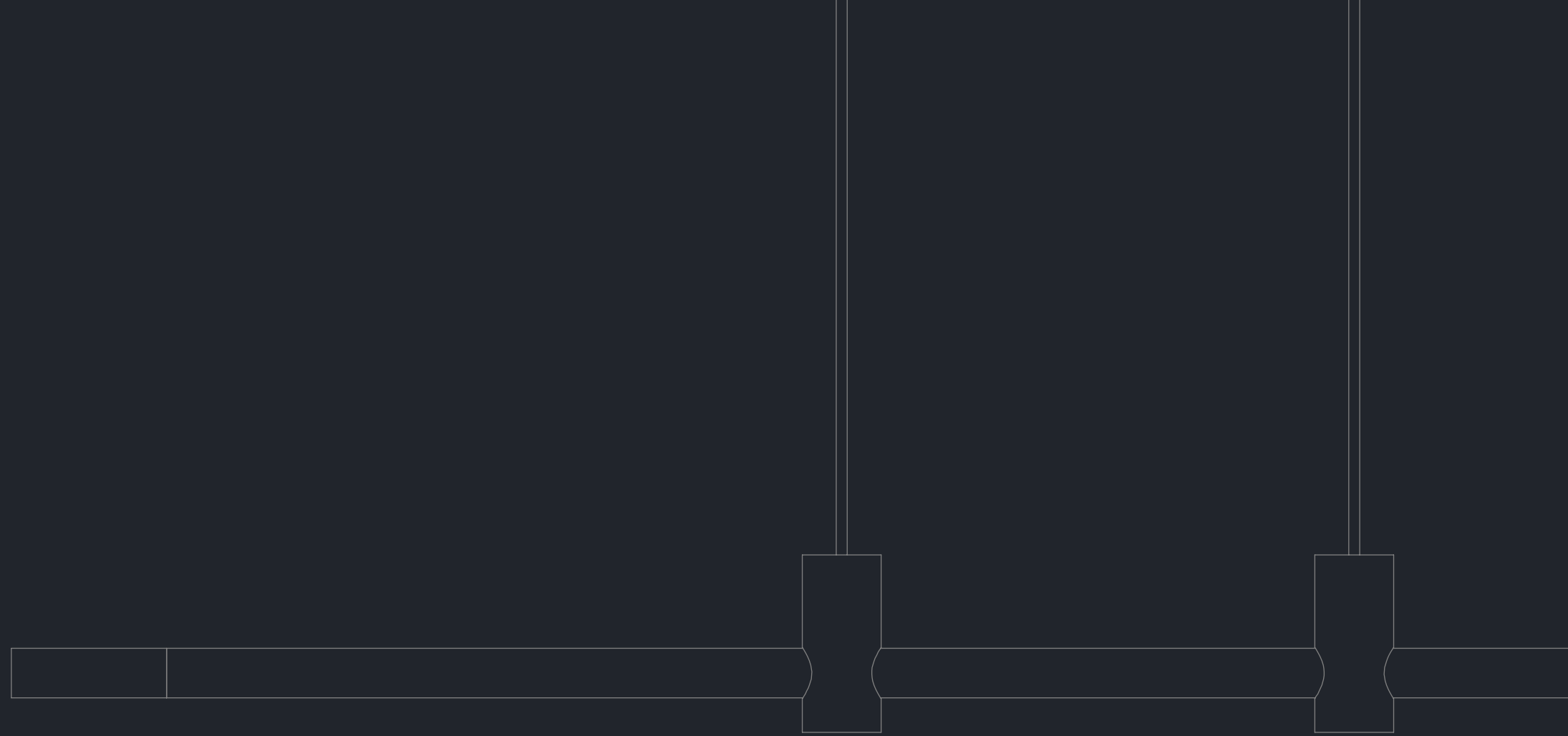



Ra — Line

Ra Line Materials

Borosilicat glass, solid bronze
& painted aluminum

Ra Line Colors

- Translucid amber
- Opaque black
-
- Natural bronze (Details)
- Oxydixed bronze (Details)

Ra Line Lighting

Cold cathode neon
2800k, 1125 lumens
220/240V dimmable
120V non-dimmable

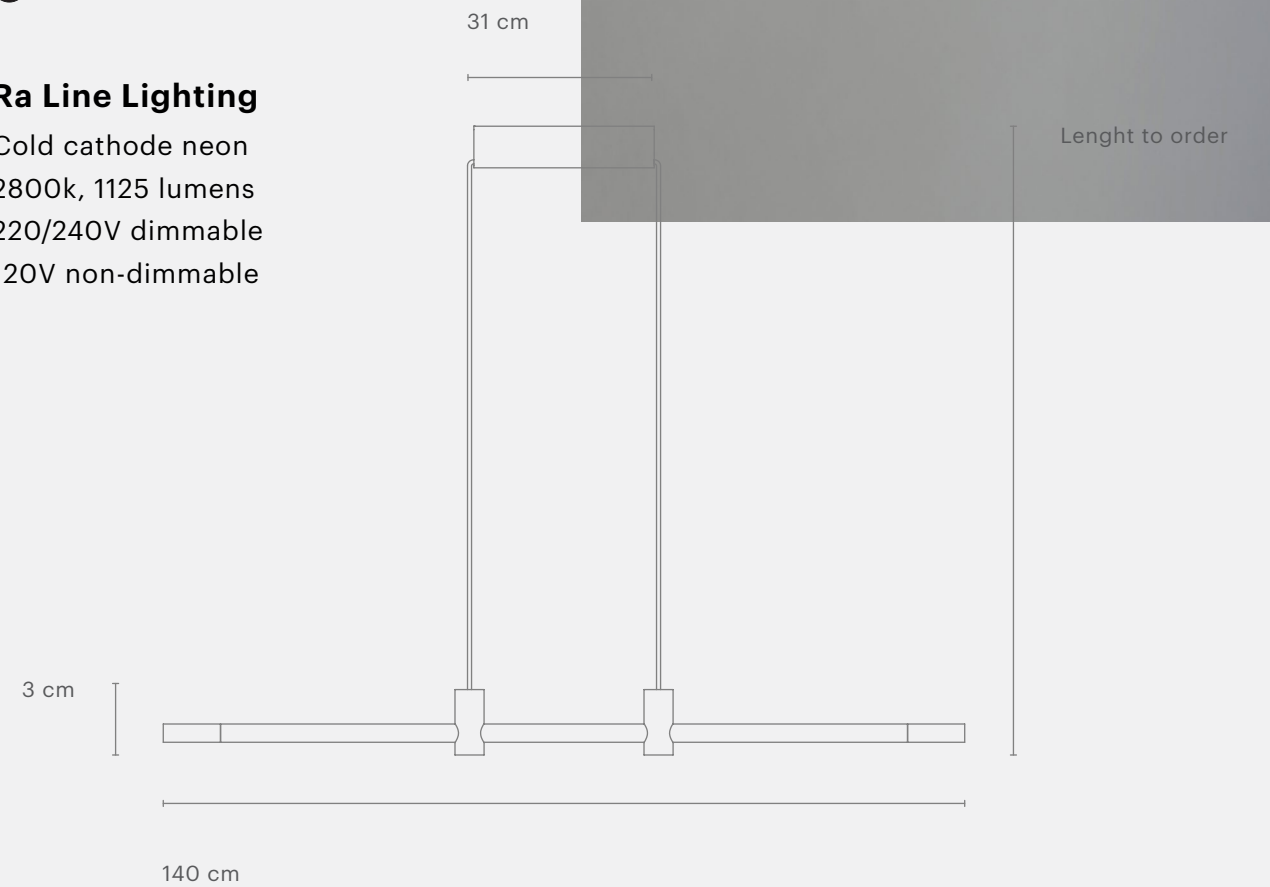



Ra — Wall

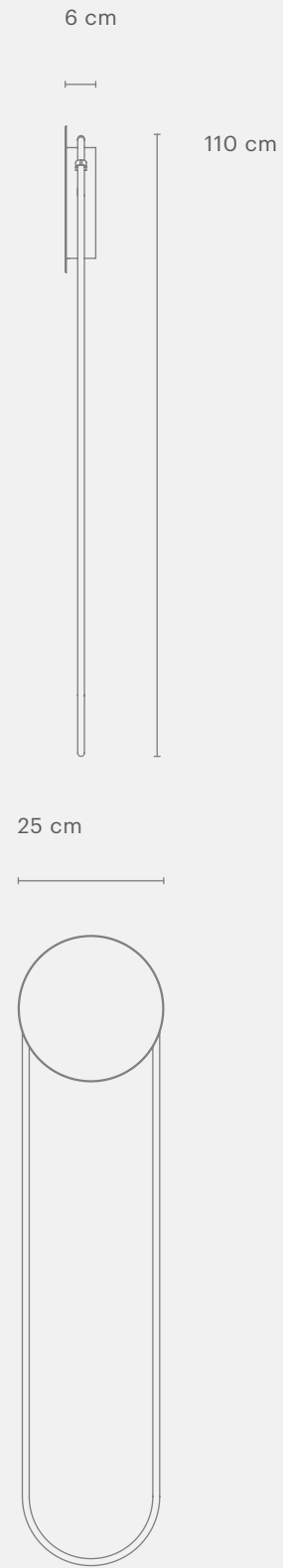

Ra Wall Materials

Hand-bent glass tube,
solid bronze & painted steel

Ra Wall Colors

- Natural bronze
- Custom finishes

Ra Wall Lighting

Cold cathode neon
2800k, 1800 lumens
220/240V dimmable
120V non-dimmable

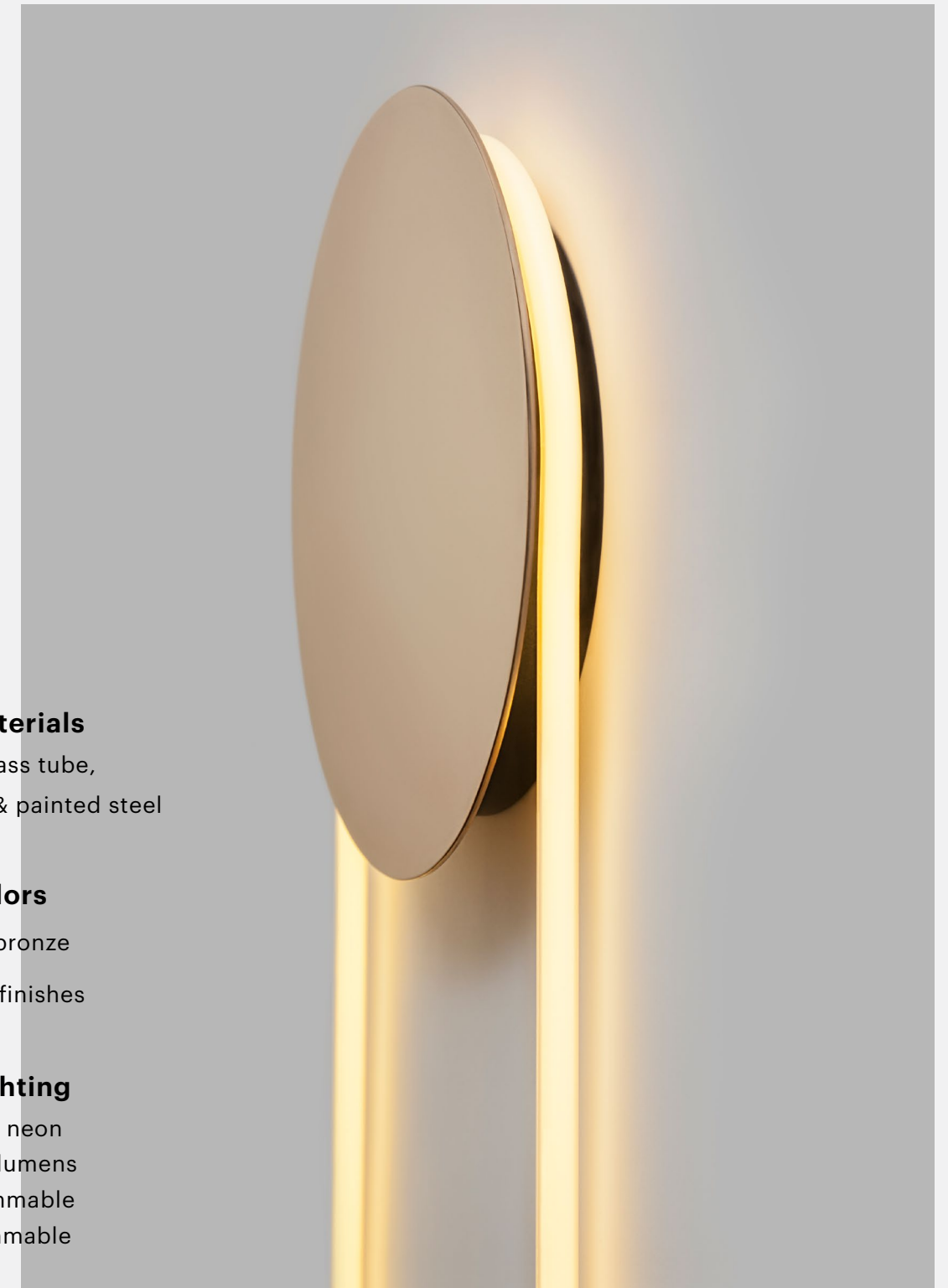

Ra — Pendant

Ra pendant Materials

Aluminium, glass & brass

Ra pendant Colors

- Matte black, Ral 9011
- Matte white, Ral 9010
-
- Natural brass (Details)
- Oxydixed brass (Details)

Ra pendant Lighting

Cold cathode neon
2800k, 1800 lumens
220/240V dimmable
120V non-dimmable



Neon has long evoked images of harsh, white commercial lighting or bright, coloured flashy signs in the dark. D'Armes gave neon a new use by distinctively shaping it to become the centrepiece of warm and luxurious lighting design. The glass neon tubes, bent manually, contain a mixture of gaz and rare minerals that produce a warm, dimmable light with surprising features: 2800k - 1800 lumens.



J.
James